



# **Intel® Server System R1000WF Product Family**

## ***System Integration and Service Guide***

A guide providing instructions for the installation and replacement of system components, and available Intel accessories and spares.

**Rev 2.4**

**January 2022**

Intel® Server Products and Solutions

<This page is intentionally left blank>

## Document Revision History

Date	Revision	Changes
July 2017	1.0	Production Release
August 2017	1.1	Figure 13 modified.
November 2017	1.2	<ul style="list-style-type: none"> <li>• Added Retimer accessory information on the sections: 2.8.3 4 - Port PCIe Retimer Cabling and 2.8.6 NVMe* Drive Population Rules for Intel® VROC</li> <li>• Updated 20 illustrations to latest versions</li> </ul>
January 2019	2.0	Added support for 2 <sup>nd</sup> Gen Intel® Xeon® processor Scalable family and Intel® Optane™ DC persistent memory modules
April 2019	2.1	Figure 92 modified.
April 2019	2.2	<ul style="list-style-type: none"> <li>• Replaced Figure 76.</li> <li>• Added title for Figure 82</li> <li>• Corrected reference errors on page 92</li> </ul>
January 2020	2.3	<ul style="list-style-type: none"> <li>• Updated Preface section to include EU Lot 9 product collateral support links</li> <li>• Added system integration support for R1208WFxxx chassis</li> <li>• Updated Figure 96 – added 12V STND-BY LED</li> </ul>
January 2022	2.4	<ul style="list-style-type: none"> <li>• Added Appendix F Safety Instructions</li> <li>• Removed initial safety information</li> </ul>

## ***Disclaimers***

No license (express or implied, by estoppel or otherwise) to any intellectual property rights is granted by this document.

Intel disclaims all express and implied warranties, including without limitation, the implied warranties of merchantability, fitness for a particular purpose, and non-infringement, as well as any warranty arising from course of performance, course of dealing, or usage in trade.

The products and services described may contain defects or errors known as errata which may cause deviations from published specifications. Current characterized errata are available on request.

You may not use or facilitate the use of this document in connection with any infringement or other legal analysis concerning Intel products described herein. You agree to grant Intel a non-exclusive, royalty-free license to any patent claim thereafter drafted which includes subject matter disclosed herein.

Intel, the Intel logo, are trademarks of Intel Corporation in the U.S. and/or other countries.

\*Other names and brands may be claimed as the property of others.

© Intel Corporation.

## Warnings

**Heed safety instructions:** Before working with your server product, whether you are using this guide or any other resource as a reference, pay close attention to the safety instructions. You must adhere to the assembly instructions in this guide to ensure and maintain compliance with existing product certifications and approvals. Use only the described, regulated components specified in this guide. Use of other products/components will void the UL listing and other regulatory approvals of the product and will most likely result in noncompliance with product regulations in the region(s) in which the product is sold.

**System power on/off:** The power button DOES NOT turn off the system AC power. To remove power from the system, you must unplug the AC power cord from the wall outlet. Make sure the AC power cord is unplugged before you open the chassis, add, or remove any components.

**Hazardous conditions, devices and cables:** Hazardous electrical conditions may be present on power, telephone, and communication cables. Turn off the server and disconnect the power cord, telecommunications systems, networks, and modems attached to the server before opening it. Otherwise, personal injury or equipment damage can result.

**Installing or removing jumpers:** A jumper is a small plastic encased conductor that slips over two jumper pins. Some jumpers have a small tab on top that you can grip with your fingertips or with a pair of fine needle nosed pliers. If your jumpers do not have such a tab, take care when using needle nosed pliers to remove or install a jumper; grip the narrow sides of the jumper with the pliers, never the wide sides. Gripping the wide sides can damage the contacts inside the jumper, causing intermittent problems with the function controlled by that jumper. Take care to grip with, but not squeeze, the pliers or other tool you use to remove a jumper, or you may bend or break the pins on the board.

**Slide / Rail mounted equipment is not to be used as a shelf or a work space**



### Electrostatic Discharge (ESD)

Electrostatic discharge can cause damage to your computer or the components within it. ESD can occur without the user feeling a shock while working inside the system chassis or while improperly handling electronic devices like processors, memory or other storage devices, and add-in cards.



Intel recommends the following steps be taken when performing any procedures described within this document or while performing service to any computer system.

- Where available, all system integration and/or service should be performed at a properly equipped ESD workstation
- Wear ESD protective gear like a grounded antistatic wrist strap, sole grounders, and/or conductive shoes
- Wear an anti-static smock or gown to cover any clothing that may generate an electrostatic charge
- Remove all jewelry
- Disconnect all power cables and cords attached to the server before performing any integration or service
- Touch any unpainted metal surface of the chassis before performing any integration or service
- Hold all circuit boards and other electronic components by their edges only
- After removing electronic devices from the system or from their protective packaging, place them component side up on to a grounded anti-static surface or conductive foam pad. Do not place electronic devices on to the outside of any protective packaging.

## Preface

### About this document

This document is written for system integrators and service technicians who are responsible for system assembly, server upgrades, server repair, and component replacement.

This document is divided into two major sections. The first half of the document provides detailed instructions on how to assemble a system from the bare chassis to a functional server. It will guide you through the installation of system components and available accessories. The second half of the document is focused on system service. It provides many reference diagrams used to identify all key physical features of the system. It also provides detailed instructions for the replacement of field replaceable components.

Access the following Intel web site for the latest revision of this document, and to download additional product documentation, specs, on board device drivers, and utility software drivers

<https://www.intel.com/content/www/us/en/support/products/89017/server-products/server-systems/intel-server-system-r1000wf-family.html>

### Additional Information and Software

The following tables list available support collaterals and documentation for this product family.

**Table 1. Server System References**

For this information or software	Use this Document or Software
For in-depth technical information about this product family	<ul style="list-style-type: none"> <li>Intel® Server Board S2600WF Technical Product Specification (TPS)</li> <li>Intel® Server System R1000WF Product Family Technical Product Specification</li> <li>Intel® Remote Management Module 4 (Intel® RMM4) and Integrated BMC User Guide</li> <li>Intel® Remote Management Module 4 Technical Product Specification</li> <li>Intel® Server System BIOS Setup Utility Guide</li> </ul>
For system integration/assembly and disassembly instructions and service guidance	Intel® Server System R1000WF product family System Integration and Service Guide
For server configuration guidance and compatibility	<ul style="list-style-type: none"> <li>Intel® S2600WF Product Family Configuration Guide</li> <li>Intel® Online Server Configurator Tool</li> </ul>
To determine a system power budget	Intel® Server Board S2600WF Product Family Power Budget Tool and Thermal Configuration Guide
For system firmware updates, onboard device drivers, and software to manage your Intel® Server System	<a href="https://www.intel.com/content/www/us/en/support/products/89017/server-products/server-systems/intel-server-system-r1000wf-family.html">https://www.intel.com/content/www/us/en/support/products/89017/server-products/server-systems/intel-server-system-r1000wf-family.html</a>
For a complete list of supported processors, memory, add-in cards, and peripherals	Intel® Online Server Configurator Tool
For product regulatory information. Declaration of Conformity: R1000	<a href="https://www.intel.com/content/www/us/en/declaration-of-conformity/cprs-doc/docs-servers.html">https://www.intel.com/content/www/us/en/declaration-of-conformity/cprs-doc/docs-servers.html</a> Also see product TPS rev 2.3 or later

The server system has support for several software utilities, which can be used to configure system parameters and aid in troubleshooting system issues.

**Table 2. System Utility Software**

To do this:	Use this utility:
TO OBTAIN FULL SYSTEM INFORMATION	INTEL® SYSINFO UTILITY – VARIOUS OS SUPPORT
TO READ SYSTEM EVENT LOG (SEL)	INTEL® SELVIEW UTILITY – VARIOUS OS SUPPORT
CONFIGURE, SAVE AND RESTORE VARIOUS SYSTEM OPTIONS	INTEL® SYSCFG UTILITY – VARIOUS OS SUPPORT
TO UPDATE SYSTEM SOFTWARE: BIOS, BMC FW, ME FW, FRU/SDR DATA	SYSTEM UPDATE PACKAGE (SUP) – UEFI ONLY INTEL® ONE BOOT FLASH UPDATE (OFU) – VARIOUS OS SUPPORTS  Note: Download update package for Intel® Server Board S2600WF product family
TO CONFIGURE AND MANAGE INTEL® RAID CONTROLLERS	INTEL® RAID WEB CONSOLE 2 UTILITY – VARIOUS OS SUPPORT
SERVER MANAGEMENT SOFTWARE	INTEL® ACTIVE SYSTEM CONSOLE

In compliance with the European Union (EU) regulatory CE marking directive 2019/424 (Lot 9) materials efficiency requirements, Intel makes available all necessary product collaterals as identified below:

- **Product Serviceability Instructions**

- Intel® Server System R1000WF Product Family System Integration and Service Guide (This document)  
<https://www.intel.com/content/www/us/en/support/products/89017/server-products/server-systems/intel-server-system-r1000wf-family.html>

- **Product Specifications**

- Intel® Server System R1000WF Product Family Technical Product Specification
- Intel® Server Board S2600WF Product Family Technical Product Specification  
<https://www.intel.com/content/www/us/en/support/articles/000023750/server-products/server-boards.html>

- **System BIOS/Firmware and Security Updates – Intel® Server Board S2600WF Family**

- System Update Package (SUP) – uEFI only
- Intel® One Boot Flash Update (OFU) – Various OS Support  
<https://www.intel.com/content/www/us/en/support/products/89017/server-products/server-systems/intel-server-system-r1000wf-family.html>

- **Intel® Solid State Drive (SSD) Secure Data Deletion and Firmware Updates**

- Note: for system configurations that may be configured with an Intel SSD
- Intel® Solid State Drive Toolbox  
<https://downloadcenter.intel.com/download/29205?v=t>

- **Intel® RAID Controller Firmware Updates and other support collaterals**

- Note: for system configurations that may be configured with an Intel® RAID Controller  
<https://www.intel.com/content/www/us/en/support/products/43732/server-products/raid-products.html>

## Document Organization

### System Integration

**Chapter 1** — Server Building Block System Integration – provides grounds up assembly instructions for the integration of individual server building blocks, starting with a bare chassis and installing all the system boards and major server components, including power supply and system fans. This chapter can be skipped if the server board and other major components are pre-installed in the system.

**Chapter 2** – Essential System Component Integration and Service – provides instructions for adding essential system components required to complete the integration of the server system. This includes installation of Processors, Memory, Add-in Cards, and hot-swap storage devices

**Chapter 3** – Options and Accessory Kit Integration and Service – provides instructions for adding and removing various system options and available accessory option kits that maybe installed in the system.

**Chapter 4** – System Software Updates and Configuration - provides instructions for completing the integration of the server system by updating the system software and navigating through the BIOS Setup screens.

**Chapter 5** – System Packaging Assembly – Provides package assembly instructions when re-using the Intel packaging the system was originally shipped in.

### System Service

**Chapter 6 - System Features Overview** – provides a high-level overview of the Intel® Server System R1000WF product family. In this chapter, you will find a list of the server system features and illustrations identifying the major system components.

**Chapter 7 – FRU Replacement** – provides guidance for the replacement of system components considered as field replaceable units (FRUs).

**Appendix A – Getting Help**

**Appendix B – System Cable Routing Diagrams**

**Appendix C – System Status LED Operating States and Definition**

**Appendix D – POST Code Diagnostic LED Decoder Table**

**Appendix E – POST Code Errors**



## **Table of Contents**

<b>1. Server Building Block System Integration.....</b>	<b>15</b>
1.1 Intel Server Chassis Identification and Supplied Components List.....	16
1.1.1 Chassis Component Identification.....	18
1.2 Prepare Chassis for Assembly .....	18
1.3 System Assembly.....	19
1.3.1 Power Supply Module Installation.....	28
<b>2. Essential System Component Installation and Service .....</b>	<b>29</b>
2.1 Internal Cable Routing Channels.....	30
2.2 System Cover Removal / Installation.....	31
2.2.1 System Cover Removal.....	31
2.2.2 System Cover Installation.....	31
2.3 Air Duct Removal / Installation.....	32
2.3.1 Air Duct Removal.....	32
2.3.2 Air Duct Installation.....	32
2.4 Processor Assembly, Installation, and Replacement.....	33
2.4.1 PHM Assembly .....	34
2.4.2 Processor Installation.....	37
2.4.3 Processor Replacement.....	40
2.5 Memory Module (DIMM) Installation and Replacement .....	42
2.5.1 DDR4 DIMM Installation .....	43
2.5.2 DDR4 DIMM Replacement .....	44
2.6 Drive Carrier Extraction, Installation, and Assembly .....	45
2.6.1 Drive Carrier Extraction.....	45
2.6.2 Drive Carrier Installation .....	45
2.6.3 2.5" HDD/SSD Drive Carrier Assembly (Intel® Server System R1208WFxxxx) .....	46
2.6.4 3.5" HDD/SSD Drive Assembly (Intel® Server R1304WFxxx) .....	47
2.6.5 2.5" SSD into a 3.5" Drive Carrier Assembly (Intel® Server R1304WFxxx) .....	48
2.7 Riser Card Bracket Assembly - Removal / Integration / Installation .....	51
2.7.1 Riser Card Bracket Removal.....	51
2.7.2 PCIe* Add-in Card Installation.....	51
2.7.3 Riser Card Bracket Installation .....	52
2.8 PCIe* NVMe SSD Support – (R1208WFxxx only) .....	53
2.8.1 Onboard PCIe* OCuLink Connector Cabling .....	53
2.8.2 4 - Port PCIe* Switch Cabling.....	54
2.8.3 4 - Port PCIe* Retimer Cabling .....	55
2.8.4 Installing the Intel® VROC Upgrade Key .....	57
2.8.5 Removing the Intel® VROC Upgrade Key.....	57
2.8.6 NVMe* Drive Population Rules for Intel® VROC .....	57
<b>3. Option and Accessory Kit Integration and Service .....</b>	<b>62</b>
3.1 Power Supply Module – Installation / Removal .....	63

3.1.1	2 <sup>nd</sup> Power Supply Module Installation .....	63
3.1.2	Power Supply Module Removal.....	63
3.1.3	Power Cord Retention Strap Installation .....	64
3.1.4	Power Cord Retention Strap Removal.....	64
3.2	ESRT2 SATA RAID 5 Upgrade Key – Installation / Removal.....	65
3.2.1	Installing the ESRT2 SATA RAID 5 Upgrade Key .....	65
3.2.2	Removing the ESRT2 SATA RAID 5 Upgrade Key.....	65
3.3	Intel® Remote Management Module 4 Lite Key – Installation / Removal .....	66
3.3.1	Intel® RMM4 Lite Key Installation .....	66
3.3.2	Intel® RMM4 Lite Key Removal .....	66
3.4	Trusted Platform Module (TPM) Installation.....	67
3.5	M.2 Storage SSD Installation / Removal.....	67
3.5.1	M.2 Storage SSD Installation.....	68
3.5.2	M.2 Storage SSD Removal.....	68
3.6	OCP Expansion Module – Installation / Removal .....	69
3.6.1	OCP Expansion Module Installation.....	69
3.6.2	OCP Expansion Module Removal.....	69
3.7	Intel® SAS RAID Module Installation / Removal .....	70
3.7.1	Intel® SAS RAID Module Installation .....	70
3.7.2	Intel® SAS RAID Module Removal.....	70
3.8	Single Intel® RAID Maintenance Free Backup Unit (RMFBU) Installation/Removal .....	71
3.8.1	Single Intel® RAID Maintenance Free Backup Unit (RMFBU) Installation.....	71
3.8.2	Single Intel® RAID Maintenance Free Backup Unit (RMFBU) Removal .....	71
3.9	Dual Intel® RAID Maintenance Free Backup Units (RMFBU) Installation/Removal .....	72
3.9.1	Dual Intel® RAID Maintenance Free Backup Unit (RMFBU) Assembly Installation.....	72
3.9.2	Dual Intel® RAID Maintenance Free Backup Unit (RMFBU) Assembly Removal.....	73
3.10	Intel® Omni-Path IFT Carrier Accessory Kit Installation.....	74
3.10.1	Intel® Omni-path IFT Carrier Kit (iPC AWF1PFABKITM) – Installation .....	74
3.10.2	Intel® Omni-path IFT Carrier Kit (iPC AWF1PFABKITP) – Installation .....	76
<b>4.</b>	<b>System Software Updates and Configuration.....</b>	<b>79</b>
4.1	Updating the System Software Stack.....	79
4.2	Using the BIOS Setup Utility.....	79
4.2.1	Entering BIOS Setup .....	79
4.2.2	No Access to the BIOS Setup Utility.....	79
4.2.3	Navigating the BIOS Setup Utility.....	80
<b>5.</b>	<b>System Packaging Assembly .....</b>	<b>82</b>
5.1	Accessory Kit.....	82
<b>6.</b>	<b>System Service - System Features Overview .....</b>	<b>89</b>
6.1	System Feature Reference Diagrams.....	89
6.1.1	Front Drive Bay Options .....	90
6.1.2	Control Panel Features .....	90
6.1.3	Front I/O Features.....	90

6.1.4	Back Panel Features.....	90
6.1.5	Server Board Features.....	91
6.2	System Configuration and Recovery Jumpers .....	94
6.2.1	BIOS Default Jumper Block .....	94
6.2.2	Password Clear Jumper Block.....	95
6.2.3	Management Engine (ME) Firmware Force Update Jumper Block.....	95
6.2.4	BMC Force Update Jumper Block .....	96
6.2.5	BIOS Recovery Jumper .....	97
6.2.6	Serial Port 'A' Configuration Jumper .....	97
<b>7.</b>	<b>System Service - FRU Replacement .....</b>	<b>98</b>
7.1	Replacing a System Fan.....	98
7.2	Replacing the System Battery.....	101
7.3	Rack Handles – Installation / Removal.....	102
7.3.1	Installing the Rack Handles.....	102
7.3.2	Removing the Rack Handles.....	102
7.4	Replacing a Backplane .....	103
7.4.1	Removing the Backplane .....	103
7.4.2	Installing the Backplane .....	104
7.5	Replacing the Standard Front Control Panel .....	105
7.5.1	Standard Front Control Panel Removal.....	105
7.5.2	Standard Front Control Panel Installation.....	105
7.6	Replacing a PCIe* Add-in Card .....	107
7.6.1	PCIe* Add-in Card Removal.....	107
7.6.2	PCIe* Add-in Card Installation.....	107
7.7	Replacing the Server Board .....	108
7.7.1	Server Board Removal .....	108
7.7.2	Server Board Installation .....	109
<b>Appendix A.</b>	<b>Getting Help .....</b>	<b>111</b>
<b>Appendix B.</b>	<b>System Cable Routing Diagrams .....</b>	<b>112</b>
<b>Appendix C.</b>	<b>System Status LED Operating States and Definition .....</b>	<b>114</b>
<b>Appendix D.</b>	<b>POST Code Diagnostic LED Decoder Table .....</b>	<b>116</b>
<b>Appendix E.</b>	<b>POST Code Errors .....</b>	<b>123</b>
<b>Appendix F.</b>	<b>Safety Instructions.....</b>	<b>131</b>

## List of Figures

Figure 1. Intel® Server Chassis R1304WFxxx – 4 x 3.5" Front Drive Bay .....	16
Figure 2. Intel® Server Chassis R1208WFxxx – 8 x 2.5" Front Drive Bay .....	17
Figure 3. Chassis Components .....	18
Figure 4. Chassis Cover Removal.....	18
Figure 5. System Fan Assembly Removal .....	19
Figure 6. Internal Cable Routing .....	20
Figure 7. Server Board Installation .....	21
Figure 8. SAS/SATA I/O Cable .....	22
Figure 9. Backplane Power Cable and SAS/SATA Data Cable Attachments .....	22
Figure 10. On-Board Mini-SAS HD Connectors for embedded SATA Support.....	23
Figure 11. Hot Swap Backplane Power Cable and Onboard Connector.....	23
Figure 12. System Fan Assembly Installation .....	24
Figure 13. Connect System Fan Cables .....	24
Figure 14. Hot Swap Backplane I2C Cable.....	25
Figure 15. Hot Swap Backplane I2C Internal Cable Connection .....	25
Figure 16. Backplane I2C Connector.....	25
Figure 17. Front Control Panel and Front I/O Internal Cable Connections.....	26
Figure 18. Air Duct Side Wall and Support Bracket Installation.....	27
Figure 19. Power Supply and Power Supply Bay Filler Installation .....	28
Figure 20. Internal Cable Routing.....	30
Figure 21. System Cover Removal .....	31
Figure 22. System Cover Installation .....	31
Figure 23. Air Duct Removal .....	32
Figure 24. Air Duct Installation .....	32
Figure 25. Processor Heat Sink Module (PHM) Reference Diagram.....	33
Figure 26. Processor Heat Sink Handling.....	34
Figure 27. PHM Assembly – Heat Sink Orientation.....	34
Figure 28. Processor Clip Assembly.....	35
Figure 29. Processor Clip Sub-Assembly.....	35
Figure 30. Processor Clip Sub-assembly to Heat Sink Orientation .....	36
Figure 31. Processor Heat Sink Module (PHM).....	36
Figure 32. Plastic processor socket cover removal .....	37
Figure 33. Alignment Features .....	38
Figure 34. PHM Alignment to Bolster Plate.....	38
Figure 35. Correct PHM Placement.....	39
Figure 36. Installing the PHM.....	39
Figure 37. Uninstalling the PHM .....	40
Figure 38. Plastic Processor Socket Cover Installation.....	40
Figure 39. PHM Disassembly.....	41
Figure 40. Releasing the Processor Carrier Clip from the Heat Sink .....	41

Figure 41. Releasing Processor from Carrier Clip.....	41
Figure 42. DIMM Blank.....	42
Figure 43. 1U System DIMM Slot Population Requirements for Thermal Compliance.....	42
Figure 44. DDR4 DIMM Installation.....	43
Figure 45. Memory Removal.....	44
Figure 46. Extracting Drive Carrier from Chassis .....	45
Figure 47. Installing Drive Carrier into Chassis.....	45
Figure 48. 2.5" Drive Carrier Assembly – Drive / Drive Blank Removal .....	46
Figure 49. 2.5" Drive Carrier Assembly – Drive Installation to Carrier .....	46
Figure 50. 2.5" Drive Carrier Assembly – Drive Carrier and Drive Blank Alignment Features.....	47
Figure 51. 3.5" Drive Carrier Assembly - Drive / Drive Blank Removal .....	47
Figure 52. 3.5" Drive Carrier Assembly – Drive Installation to Carrier .....	48
Figure 53. 3.5" Drive Carrier Assembly – Drive Blank Removal .....	48
Figure 54. 3.5" Drive Carrier to 2.5" SSD Bracket – Tab Removal.....	49
Figure 55. 3.5" Drive Carrier to 2.5" SSD Bracket – Mount SSD to Bracket.....	49
Figure 56. 3.5" Drive Carrier to 2.5" SSD Bracket – Mount Bracket Assembly to Carrier .....	50
Figure 57. 3.5" Drive Carrier to 2.5" SSD Bracket – Secure SSD to Carrier.....	50
Figure 58. PCI Riser Assembly Removal .....	51
Figure 59. PCI Add-In Card Installation .....	51
Figure 60. Riser Card Bracket Installation.....	52
Figure 61. Onboard PCIe* OCuLink Connectors for NVMe* SSD Support .....	53
Figure 62. Backplane PCIe* Data Cable Attachments.....	54
Figure 63. Installing the Intel® VROC Upgrade Key.....	57
Figure 64. Backplane Cabling from Two PCIe* Sources.....	58
Figure 65. Power Supply Module Installation .....	63
Figure 66. Power Supply Module Removal .....	63
Figure 67. Power Cord Retention Strap Installation.....	64
Figure 68. Power Cord Plugging .....	64
Figure 69. Installing the SATA RAID 5 Upgrade Key.....	65
Figure 70. Installing the Intel® RMM4 Lite.....	66
Figure 71. Trusted Platform Module (TPM) Installation .....	67
Figure 72. M.2 Connector Locations .....	67
Figure 73. Installing M.2 Device .....	68
Figure 74. Removing M.2 Device.....	68
Figure 75. Installing OCP Expansion Module .....	69
Figure 76. Removing an OCP Expansion Module .....	69
Figure 77. Intel® SAS RAID Module Installation.....	70
Figure 78. Single Intel® RAID Maintenance Free Backup Unit (RMFBU) Installation .....	71
Figure 79. Intel® RAID Maintenance Free Backup Unit (RMFBU) Removal .....	71
Figure 80. AWTAUXBBUBKT 1U RMFBU Mounting Plate Installation.....	72
Figure 81. RMFBU Removal From Standard Housing .....	72
Figure 82. RMFBU Installation Into Dual RMFBU Housing.....	72

Figure 83. Dual RMFBU Assembly Installation.....	73
Figure 84. Dual RMFBU assembled.....	73
Figure 85. Dual RMFBU Assembly Removal.....	73
Figure 86. Fabric Processor Cable Installation .....	75
Figure 87. Fabric Cable Processor Connector Placement.....	77
Figure 88. Package Assembly Reference Diagram .....	83
Figure 89. Intel® Server System R1000WF Features Overview.....	89
Figure 90. 3.5" Drive Bay – 4 Drive Configuration – Intel® Server System R1304WFxxxx .....	90
Figure 91. 2.5" Drive Bay – 8 Drive Configuration – Intel® Server System R1208WFxxxx .....	90
Figure 92. Control Panel Features.....	90
Figure 93. Front I/O Panel Features .....	90
Figure 94. Back Panel Features .....	90
Figure 95. Server Board Feature Identification.....	91
Figure 96. Intel® Light-Guided Diagnostic LEDs - Server Board .....	92
Figure 97. DIMM Fault LEDs.....	93
Figure 98. System Fan Connections.....	93
Figure 99. System Configuration and Recovery Jumpers.....	94
Figure 100. System Fan Assembly Removal.....	98
Figure 101. Connect System Fan Cables.....	100
Figure 102. Replacing the Backup Battery.....	101
Figure 103. Installing the Rack Handle .....	102
Figure 104. Removing the Rack Handle.....	102
Figure 105. Removing the Backplane .....	103
Figure 106. Installing the Backplane.....	104
Figure 107. Standard Front Control Panel Removal .....	105
Figure 108. Standard Front Control Panel Installation .....	105
Figure 109. Removing a PCI Add-In Card.....	107
Figure 110. PCI Add-In Card Installation.....	107
Figure 111. Server Board Removal .....	108
Figure 112. Server Board Lifting .....	109
Figure 113. Intel® Server System R1304WFxxxx Cable Routing .....	112
Figure 114. Intel Server System R1208WFxxxx Cable Routing .....	113
Figure 115. POST Diagnostic LED Location .....	116

## List of Tables

Table 1. Server System References.....	4
Table 2. System Utility Software.....	5
Table 3. BIOS Setup: Keyboard Command Bar .....	80
Table 4. System Status LED State Definitions.....	114
Table 5. POST Progress Code LED Example.....	116
Table 6. MRC Progress Codes.....	117
Table 7. MRC Fatal Error Codes .....	118
Table 8. POST Progress Codes.....	119
Table 9. POST Error Codes and Messages .....	123
Table 10. POST Error Beep Codes .....	129
Table 11. Integrated BMC Beep Codes .....	130

<This page is intentionally left blank>



# 1. Server Building Block System Integration

---

## Purpose

This chapter provides instructions for the integration of the following Intel server building blocks:

### 1U Intel® Server Chassis R1304WFXML and Intel® Server Chassis R1208FXXX

+ Any server board from the Intel® Server Board S2600WF product family

If your system came with the server board pre-installed in the chassis, you can skip this chapter and proceed to *Chapter 2 – Essential System Component Installation and Service* to continue the system integration.

In addition to the Intel server building blocks defined above, the following system components (Sold Separately) will also be needed to complete the full system integration:

- Additional SAS/SATA Data Cables (as necessary)
- Appropriate PCIe\* OCuLink Data Cables for NVMe\* support (as necessary)
- Appropriate Power Supply Module(s) (required)
- Processor(s) – Intel® Xeon® processor Scalable family
- Memory - DDR4 DIMMs
- Appropriate Power Cable(s)
- Storage Devices – HDDs, SSDs, M.2
- PCIe\* Add-in Cards
- Optional Server System Accessories

Reference the *Intel® Server S2600WF Product Family Configuration Guide* for a complete list of available accessories and spares

---

**Important Note:** All product order codes ending with 'R' identify new product versions that are available as of revision 2.0 of this document. While product order codes not ending with 'R' may be referenced within this document, only product order codes ending in '(R)' cover both SKU derivations (i.e. S2600WFT(R) covers S2600WFT and S2600WFTR).

---

## Before You Begin

Before working with your server product, observe the safety and ESD precautions found in the Warnings section at the beginning of this manual.

### Tools and Supplies Needed

- Anti-static wrist strap and conductive foam pad (recommended)
- Phillips\* (cross head) screwdriver (#1 and #2 bits)

### System Reference

All references to left, right, front, top, and bottom assume the reader is facing the front of the chassis.

### Instruction Format

Each procedure described in this chapter will follow an illustration first format. This format will give the reader the option to follow a quicker path to system integration by first seeing an illustration of the intended procedure. If necessary, the reader can then follow the step-by-step instructions that will accompany each procedure.

## 1.1 Intel Server Chassis Identification and Supplied Components List



**Figure 1. Intel® Server Chassis R1304WFxxx – 4 x 3.5" Front Drive Bay**

### Included Components

- (1) – 1U chassis with Quick Reference Label affixed to top cover
  - (4) – 3.5" hot-swap drive bays with drive carriers and drive blanks. Includes:
    - (1) 12 Gb SAS backplane – iPC **FR1304S3HSBP**
    - (4) 3.5" hot swap drive tool-less carriers – iPC **FXX35HSCAR2**
  - (1) – Pre-installed standard Control Panel assembly  
(board only – iPC **FXXFPANEL2**)
    - 260 mm front panel cable – iPN J25698-xxx
  - (1) – Pre-installed front I/O panel assembly (1 x VGA and 2 x USB)
    - 620 mm USB 3.0 cable – iPN H76899-xxx
    - 400 mm video cable – iPN H62114-xxx
  - (1) – Server board to backplane 150mm I2C cable – iPN H91171-xxx
  - (1) – 850mm mini SAS HD cable – iPC **AXXCBL850HDHRT**
  - (1) – 350mm backplane power cable – iPN H82100-xxx
  - (1) – Air duct – iPN H90054-xxx
  - (6) – Dual rotor system fans – iPC **FR1UFAN10PW**
  - (2) – CPU heat sinks, 39 fin passive – iPN J39509-xxx
  - (2) – CPU heat sink "No CPU" label inserts – iPN J16115-xxx
  - (2) – Standard CPU carriers – iPN H72851-xxx
  - (2) – 1 slot PCIe\* x16 Riser Card – iPN H88399-xxx
  - (8) – DIMM slot blanks – iPN G75158-xxx
  - (1) – Chassis Stiffener Bar – iPN J16623-xxx
  - (1) – Power supply bay blank insert
  - (2) – AC power cord retention strap assembly – iPN H23961-00x
- Server board and riser card mounting screws  
Spares for each screw type included

---

**Note:** The items listed above maybe pre-installed within the chassis, placed in the chassis for shipping, or located within a supplied accessory kit.

**Note:** Intel product codes (iPC) and Intel Part Numbers (iPN) are supplied for reference purposes only. Intel Product Codes are available to order as a spare/accessory. Components identified with an Intel Part Number (iPN) are not available as an orderable component.

---



**Figure 2. Intel® Server Chassis R1208WFxxx – 8 x 2.5" Front Drive Bay**

**Included Components**

- (1) – 1U chassis with Quick Reference Label affixed to top cover
  - (8) – 2.5" hot-swap drive bays with drive carriers and drive blanks. Includes:
    - (1) SAS/NVMe\* Combo backplane – iPC **F1U8X25S3PHS**
    - (8) 2.5" hot swap drive tool-less carriers – iPC **FXX25HSCAR3**
  - (1) – Pre-installed standard Control Panel assembly  
(board only – iPC **FXXFPANEL2**)
    - 260 mm front panel cable – iPN J25698-xxx
  - (1) – Pre-installed front I/O panel assembly (1x VGA and 2x USB)
    - 620 mm USB 3.0 cable – iPN H76899-xxx
    - 400 mm video cable – iPN H62114-xxx
  - (1) – 200mm backplane I2C cable – iPN H91170-xxx
  - (1) – 650mm mini SAS HD Cable – iPC **AXXCBL650HDHRT**
  - (1) – 850mm mini SAS HD cable – iPC **AXXCBL850HDHRT**
  - (1) – 400mm backplane power cable – iPN H82099-xxx
  - (1) – Air duct – iPN H90054-xxx
  - (6) – Dual rotor system fans – iPC **FR1UFAN10PW**
  - (2) – CPU heat sinks, 39 fin passive – iPN J39509-xxx
  - (2) – CPU heat sink “No CPU” label inserts – iPN J16115-xxx
  - (2) – Standard CPU carriers – iPN H72851-xxx
  - (2) – 1 slot PCIe\* x16 Riser Card – iPN H88399-xxx
  - (8) – DIMM slot blanks – iPN G75158-xxx
  - (1) – Chassis Stiffener Bar – iPN J16623-xxx
  - (1) – Power supply bay blank insert
  - (2) – AC power cord retention strap assembly – iPN H23961-00x
- Server board and riser card mounting screws  
Spares for each screw type included

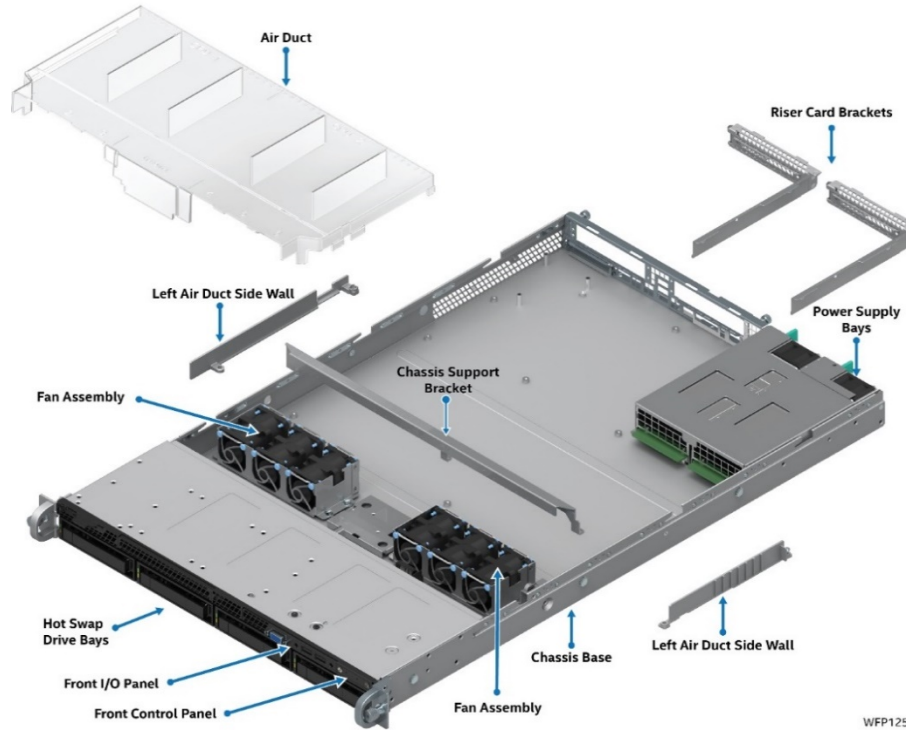
---

**Note:** The items listed above maybe pre-installed within the chassis, placed in the chassis for shipping, or located within a supplied accessory kit.

**Note:** Intel product codes (iPC) and Intel Part Numbers (iPN) are supplied for reference purposes only. Intel Product Codes are available to order as a spare/accessory. Components identified with an Intel Part Number (iPN) are not available as an orderable component.

---

### 1.1.1 Chassis Component Identification



**Figure 3. Chassis Components**

\*\* Intel Server Chassis R1304WFxxx shown

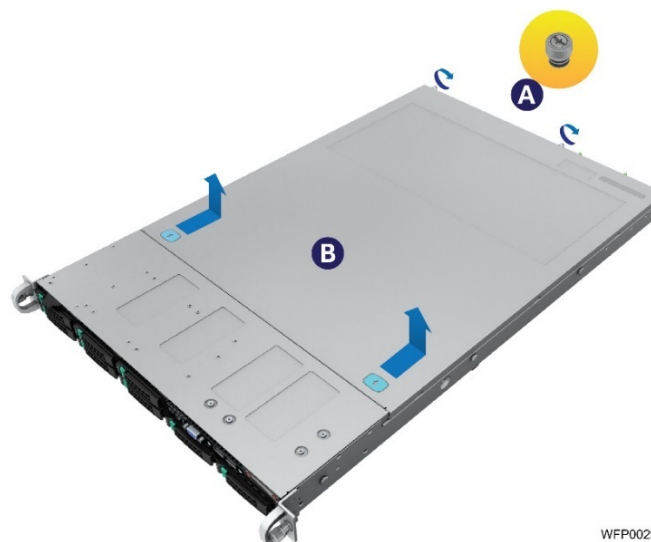
## 1.2 Prepare Chassis for Assembly

1. Remove the System Cover.

---

**Note:** A non-skid surface or a stop behind the server system may be needed to prevent the server system from sliding on your work surface.

---



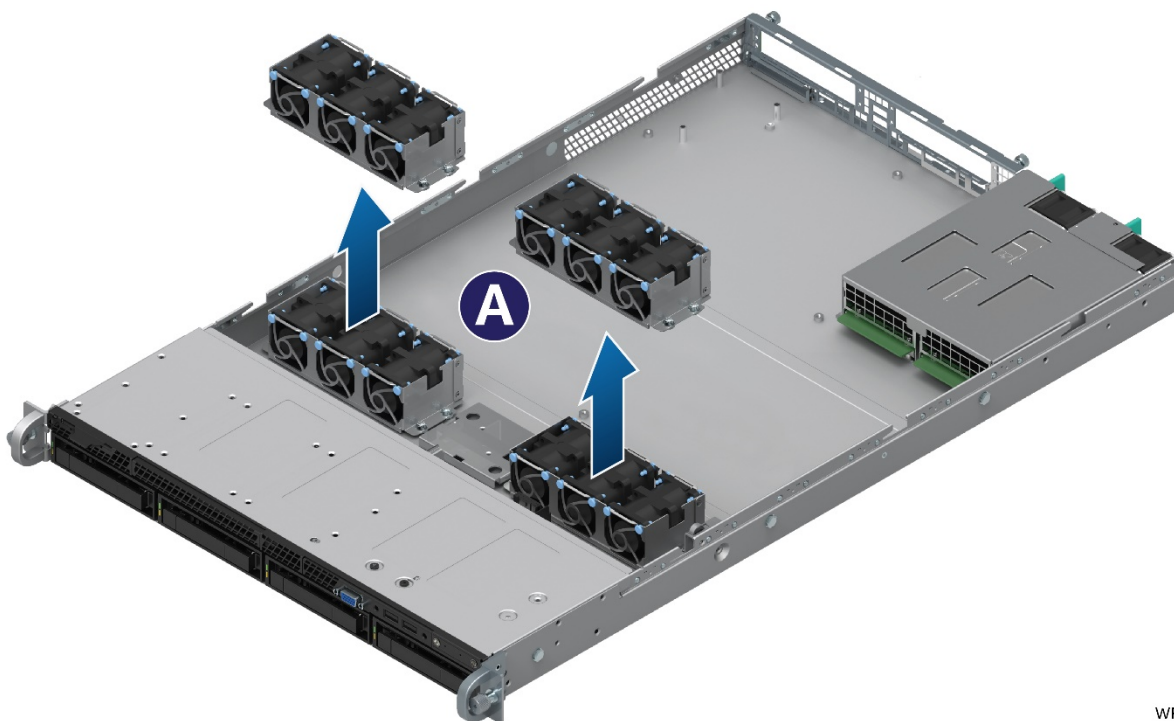
**Figure 4. Chassis Cover Removal**

- a) Loosen the two captive thumb screws located on the back edge of the system cover (See Letter "A").
- b) Slide cover back and lift upward (see Letter "B").

**Remove the following from the chassis:**

- Air Duct
- Box containing two (2) processor heat sinks
- Riser Card Brackets
- Power Supply Module (if present)

2. Remove System Fan Modules



WFP126

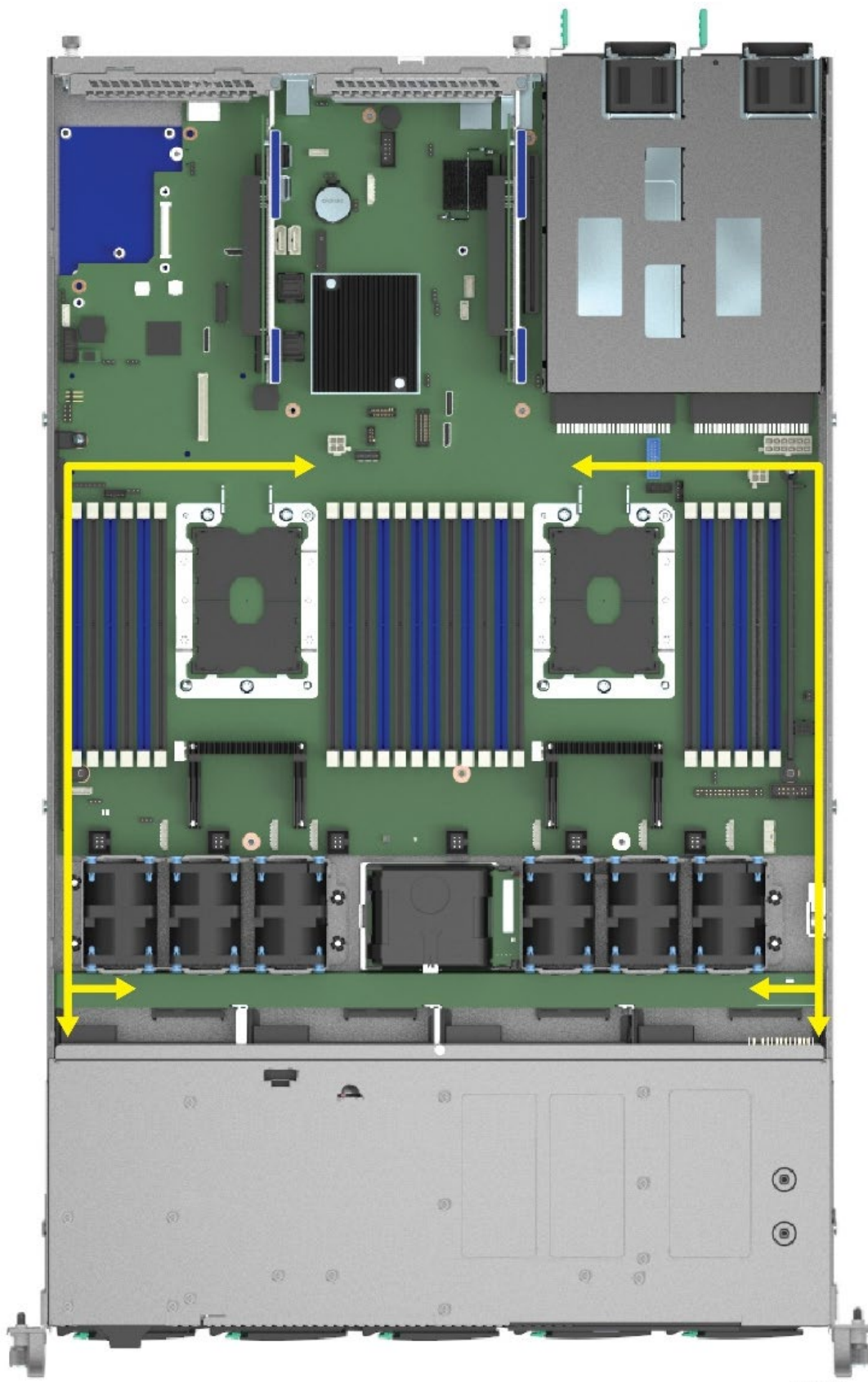
**Figure 5. System Fan Assembly Removal**

- a) Remove each fan assembly module from the chassis by grasping them on each side and pulling straight up away from the chassis mounting pins (see Letter “A”).

### 1.3 System Assembly

It is highly recommended that the system integration process defined in the following sections within this chapter be performed in the order specified. Following these instructions will result in the proper installation of critical system components and provide recommended cable routing. Deviating from the prescribed process may result in improper system assembly, a longer integration process, and a less than desired system appearance.

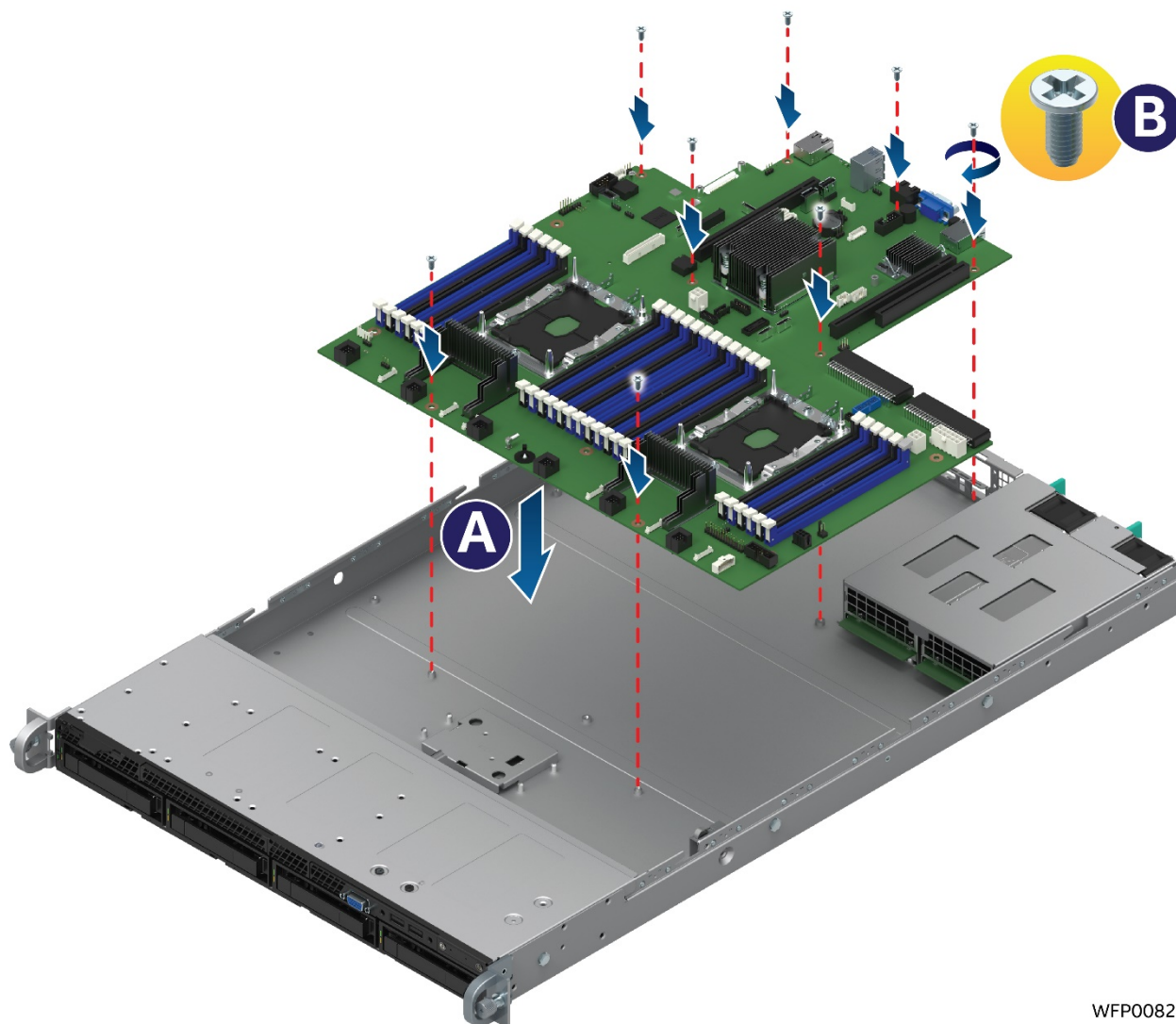
All cables should be routed using the cable channels along each chassis sidewall as shown in the following illustration. When routing cables front-to-back, none should be routed through the center of the system or in the area between the system fans and the DIMMs slots.



WFP0011

Figure 6. Internal Cable Routing

## 1. Install the Server Board



WFP0082

**Figure 7. Server Board Installation**

**Note:** Follow ESD precautions outlined at the beginning of this manual.

- Carefully move aside any cables that may be taped to the chassis base to clear the area for server board placement.
- Remove the server board from its anti-static bag.
- Holding the server board by its edges, carefully lower the server board into the chassis so that the rear I/O connectors of the server board align with and are fully seated into the matching holes on the chassis back panel and each server board mounting hole is aligned with a threaded chassis standoff.
- The server board is accurately placed when the two screw holes nearest the front edge of the server board (See Letter "A") sit securely onto the shouldered chassis standoffs.
- Using 8 in-lb. torque, fasten down the server board with eight (8) screws in the positions shown in Figure 7.

## 2. Connect Backplane SAS/SATA Data and Power Cables

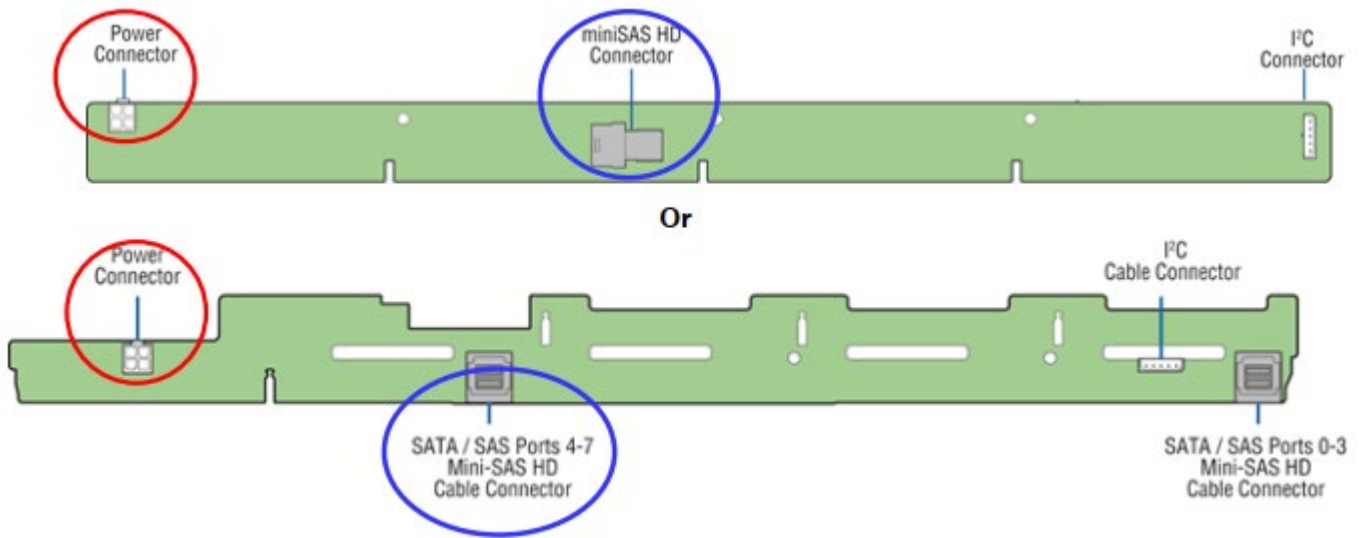
**Note:** For PCIe\* NVMe\* cabling and drive support in an R1208WFxxx based system, see Section 2.8

- a) Locate the SAS/SATA Data cable.



**Figure 8. SAS/SATA I/O Cable**

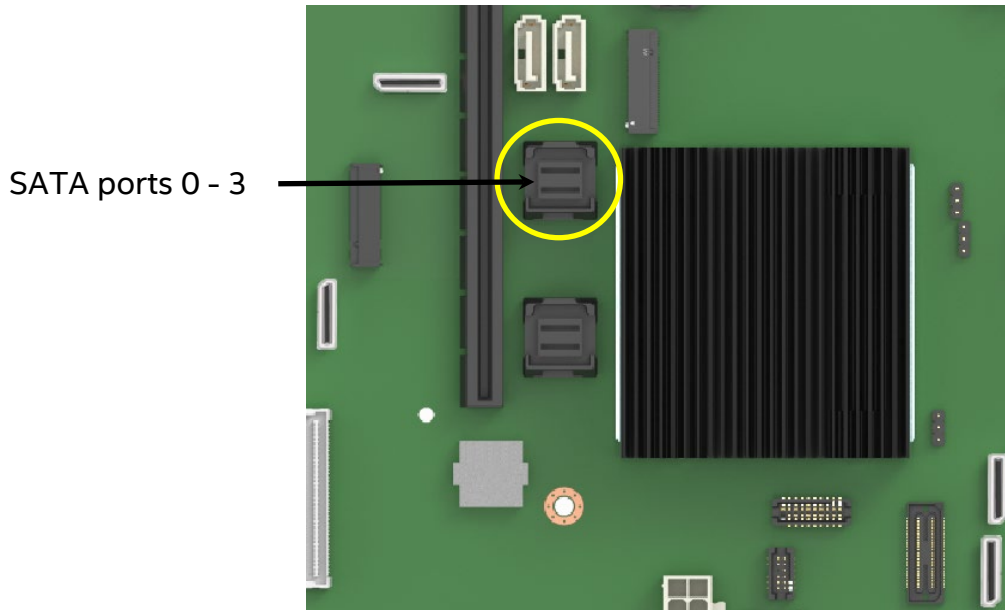
- b) Attach the P1 (Straight Connector) end of the SAS/SATA Data cable to the specified mini-SAS HD connector on the backplane (see Figure 9).
- c) Route the SAS/SATA Data cable along the base of the backplane and underneath the backplane power connector before bending the cable up along the right chassis sidewall towards the back of the system.



**Figure 9. Backplane Power Cable and SAS/SATA Data Cable Attachments**

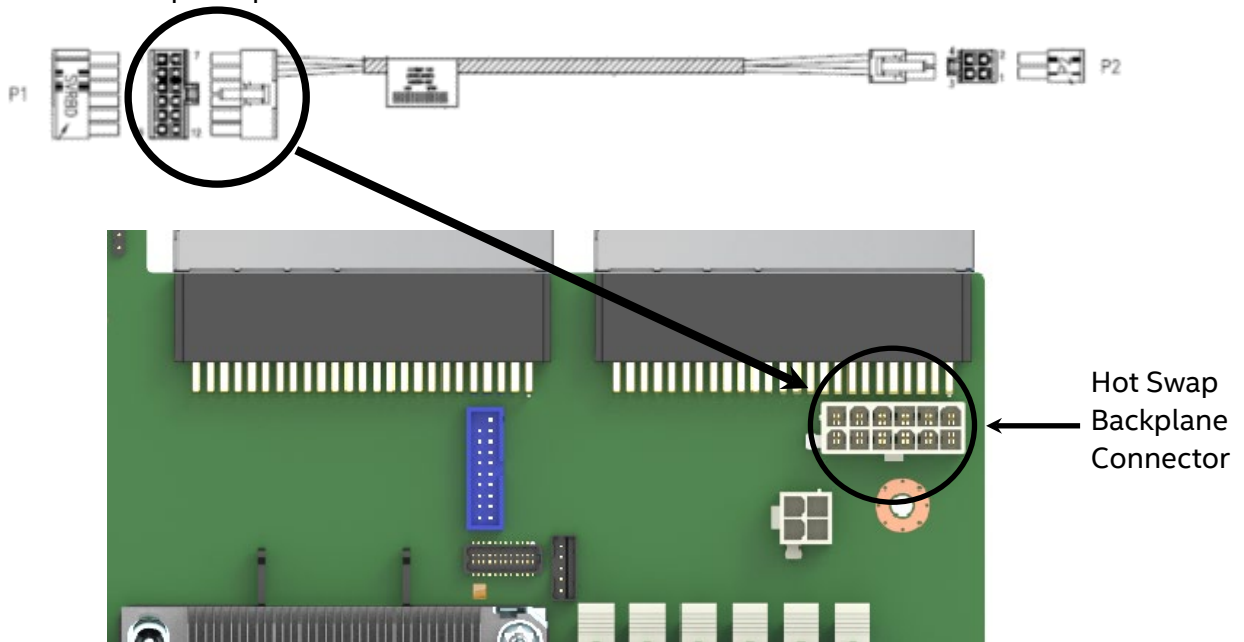
- d) For on-board SATA support, attach the P2 (angled connector) end of the SAS/SATA data cable to one of the on-board Mini-SAS HD connectors (see following illustration), or to any available SAS/SAS RAID add-in option.





**Figure 10. On-Board Mini-SAS HD Connectors for embedded SATA Support**

e) Locate the backplane power cable.



**Figure 11. Hot Swap Backplane Power Cable and Onboard Connector**

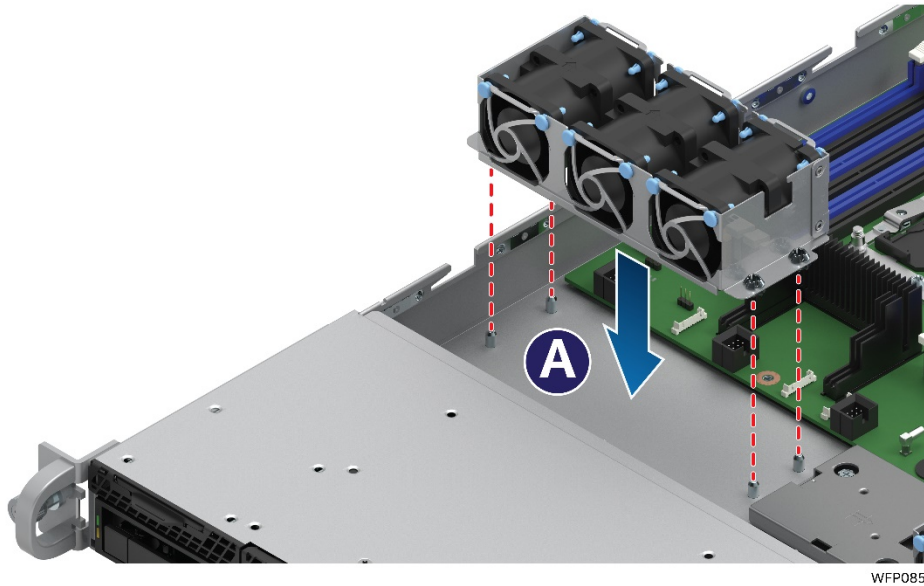
- f) Connect the 2x2 pin cable connector (labeled “P2”) to the matching power connector on the backplane (silk screened “PWR”).
- g) Route the backplane power cable along the right chassis sidewall, to the area behind the power supply bay and connect the 2x6 pin cable connector (labeled “SVRBRD”) to the matching 2x6 white power connector on the server board (silk screened “HSBP PWR”).

---

**Note:** Once the cable is attached on both ends, carefully press the cable as low as possible into the cable routing channel.

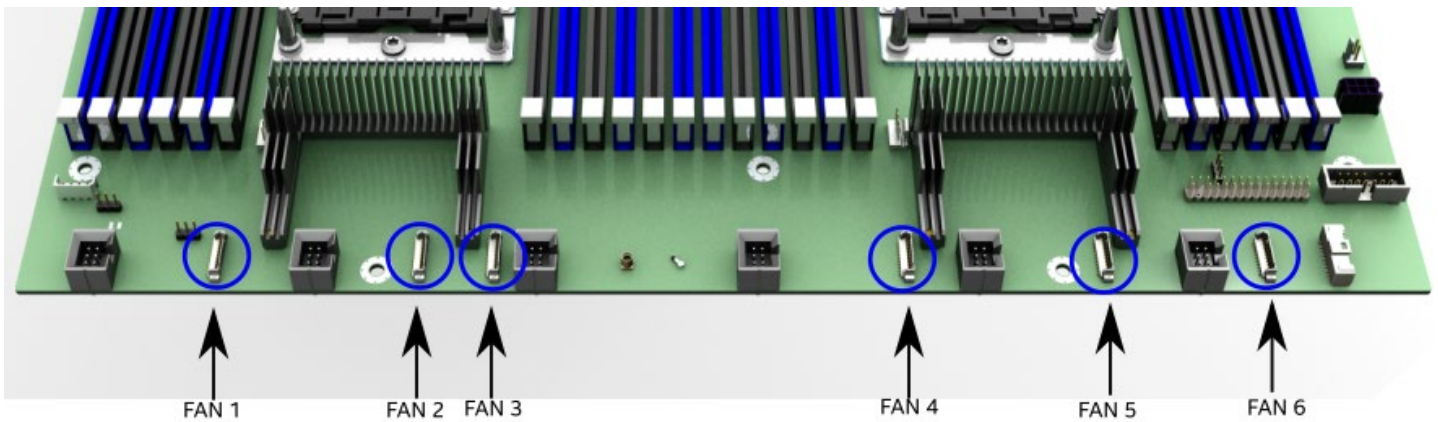
---

### 3. Install the system fan modules



**Figure 12. System Fan Assembly Installation**

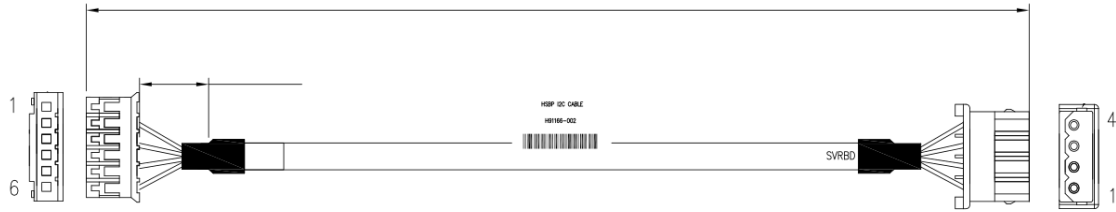
- a) Align the fan assembly with mounting pins on the chassis base and push down until firmly seated
- b) Ensure that no cables are trapped beneath the fan assembly. The fan assembly should sit level over the mounting pins.
- c) Repeat steps A & B for the second system fan module.



**Figure 13. Connect System Fan Cables**

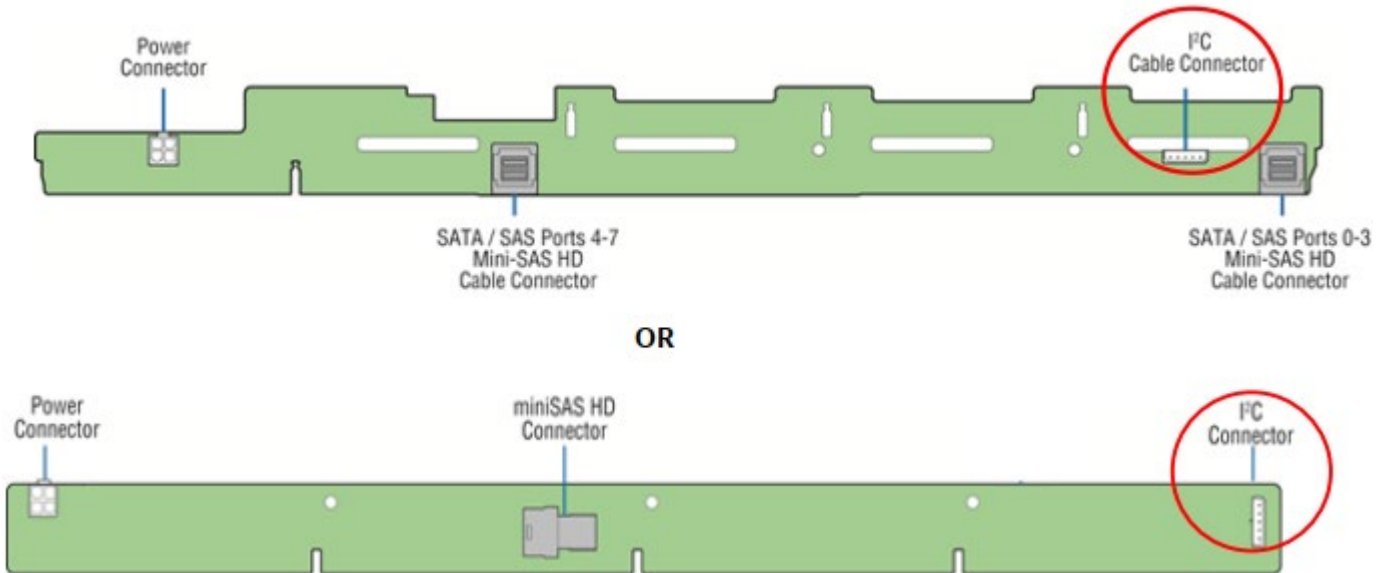
- d) Attach each fan cable to the matching 10-pin fan connector on the front edge of the server board.

#### 4. Install the Backplane I2C cable



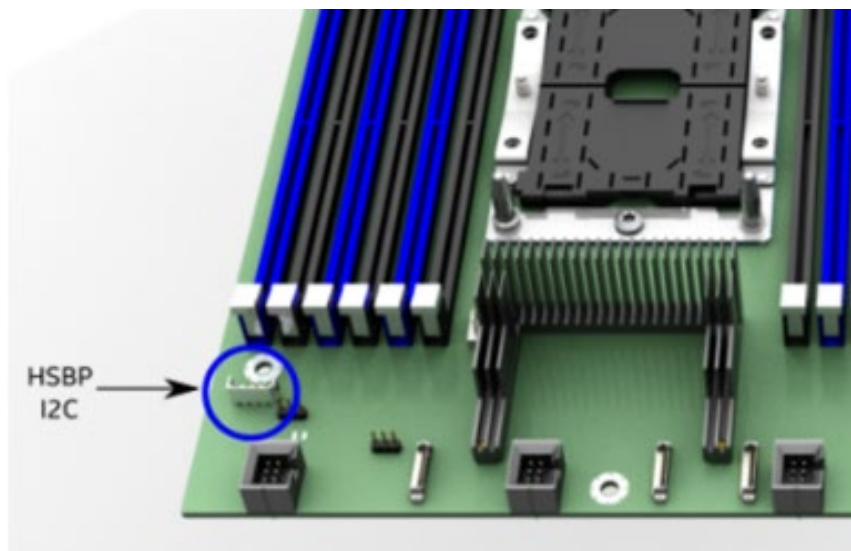
**Figure 14. Hot Swap Backplane I2C Cable**

a) Locate the backplane I<sup>2</sup>C cable.



**Figure 15. Hot Swap Backplane I2C Internal Cable Connection**

b) Attach the cable connector (labeled “HSBP”) to the white connector (silk screened “HSBP I2C”) on the backplane.

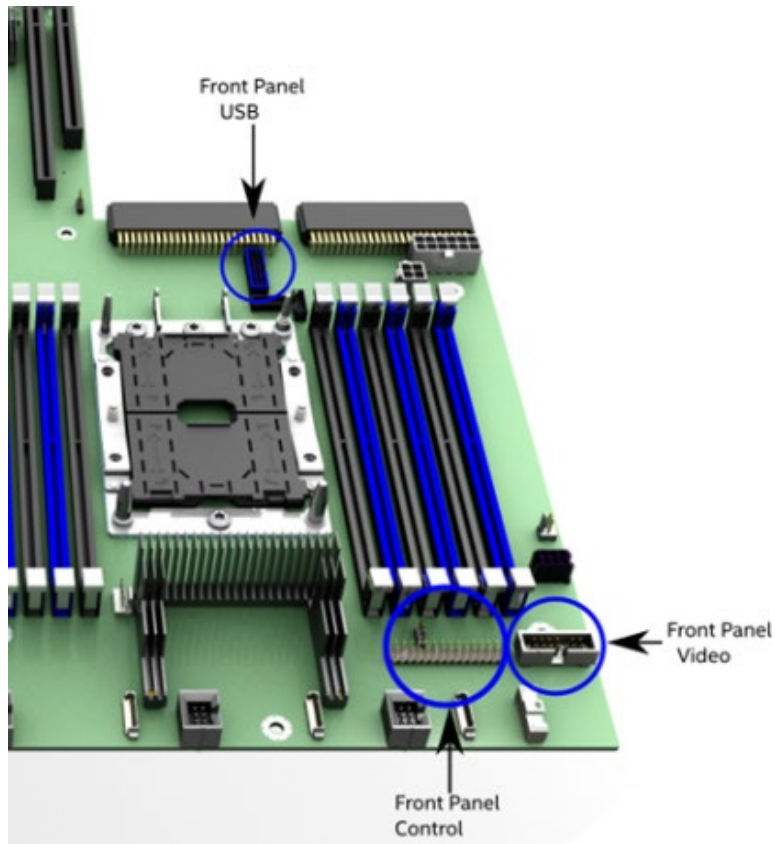


**Figure 16. Backplane I2C Connector**

c) Route the backplane I2C cable next to the nearest chassis sidewall and connect the other end of the cable to the white 1x4 pin connector (silk screened “HSBP I2C”) on the server board

## 5. Connect the Front Panel Cables

As received, the chassis should have three cables pre-attached on one end of each cable to the system front panel. The other end of each cable must be attached to matching connectors on the server board. The cables should be routed to the server board in the following order: (1) Front Control Panel, (2) Front Panel Video, and (3) Front Panel USB Ports.

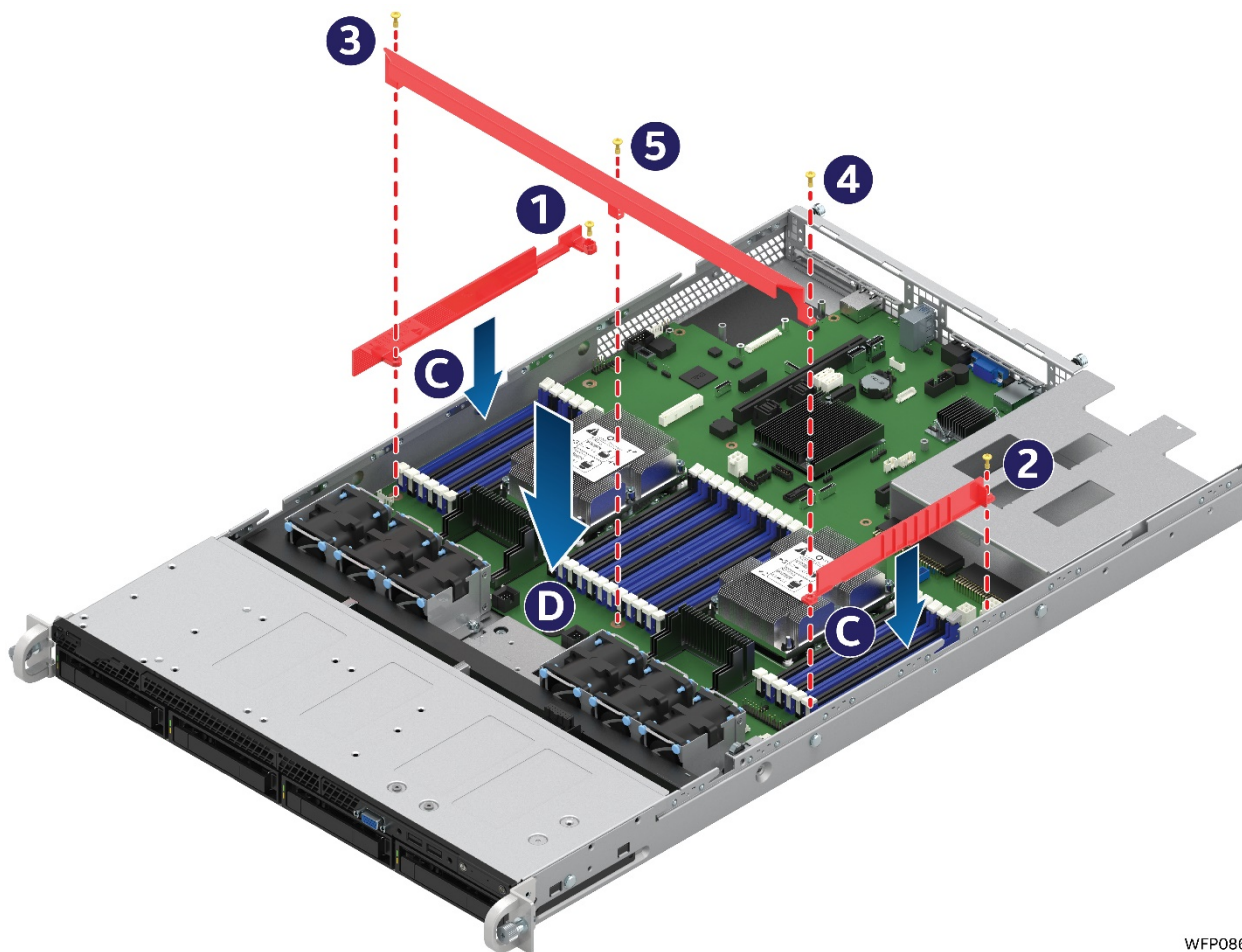


**Figure 17. Front Control Panel and Front I/O Internal Cable Connections**

- Connect the short black round cable to the 30-pin header on the server board labeled “Front Control Panel”.
- Connect the 14-pin gray folded ribbon cable to the 14-pin black shrouded connector on the server board labeled “Front Panel Video”.
- Each of the two previous cables should be routed as close to the chassis sidewall as possible.
- Route the long black round USB cable inside the cable routing channel along the chassis sidewall. At this time, **do NOT attach the USB cable to the server board.**

## 6. Install the Air Duct Side Walls and Chassis Support Bracket

The air duct sidewalls and chassis support bracket **MUST** be installed and fastened down in a specific order. Do not deviate from the provided instructions.



WFP086

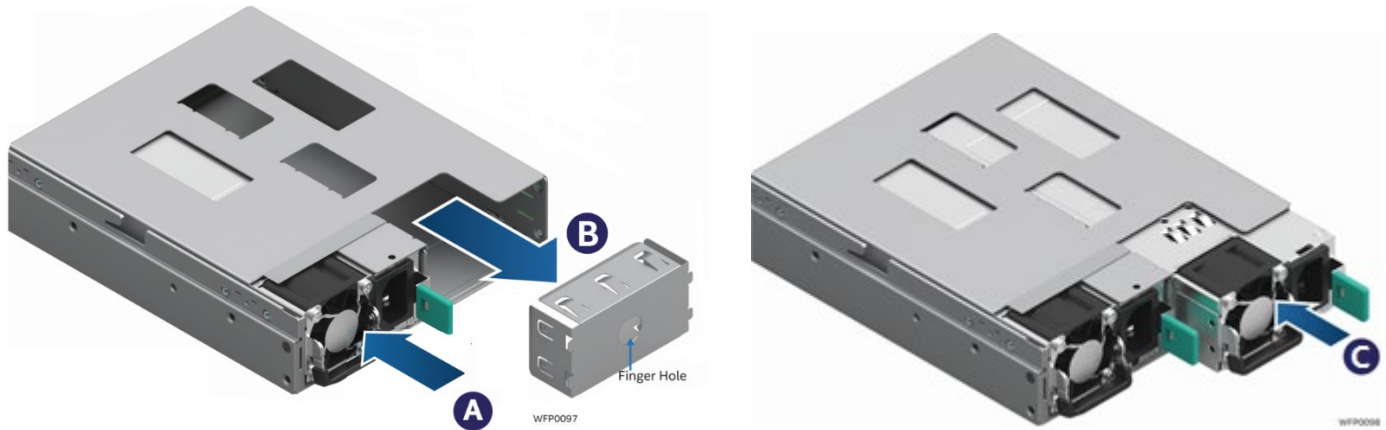
**Figure 18. Air Duct Side Wall and Support Bracket Installation**

- Locate the two black plastic air duct sidewalls.
- Following the illustration above, place the left and right air duct sidewalls onto each side of the server board (see Letter “C”)
- Using the captive screws on the side walls, loosely secure each to the server board (see numbers 1 and 2 in Figure 18).
- Locate the Chassis Support Bracket.
- Following the illustration above, position the Chassis Support Bracket onto the server board, aligning the two end mounts with the air duct sidewall mounting holes and the center mount to the mounting hole on the server board. (See Letter “D”).
- Locate the three (3) support bracket screws, two long and one short.
- Using 8 in-lb. torque, secure the Chassis Support Bracket to the server board in the order specified; outer screws (see numbers 3 and 4 in Figure 18) first, followed by the center screw (#5). Note that the center screw (see number 5 in Figure 18) is shorter than the two outer screws.
- Go back and securely tighten the air duct side wall screws (see numbers 1 and 2 in Figure 18) using 8 in-lbf. torque
- Attach the blue 20-pin cable connector of the Front USB Cable (from the previous section) to the matching blue 20-pin connector on the server board labeled “FP USB 2.0/3.0”. Push the cable down as far as possible into the cable routing channel.

### 1.3.1 Power Supply Module Installation

The server system can support 1 or 2 power supply modules.

#### 1. Install the Power Supply Module(s)



**Figure 19. Power Supply and Power Supply Bay Filler Installation**

- a) Insert the 1<sup>st</sup> power supply into the left-most power supply bay until it clicks and locks into place (See letter 'A').
- b) (Optional) To install a 2<sup>nd</sup> power supply, remove the insert from the 2<sup>nd</sup> chassis power supply bay (See letter 'B').
- c) (Optional) Install the 2<sup>nd</sup> power supply (See letter 'C').

---

**Note:** A single power supply configuration requires that the power supply bay insert be installed when the system is operational.

---

Continue to Sections 2 and 3 for installation of processors, memory, add-in cards, storage devices, and other supported options.

## 2. Essential System Component Installation and Service

---

### Purpose

This chapter provides instructions for the installation and removal of essential system components including processors, memory, storage devices, riser cards, and add-in cards.

If you are continuing the system integration from the previous chapter, you may skip ahead to section 2.4 describing processor installation.

### Before You Begin

Before working with your server product, observe the safety and ESD precautions found in the Warnings section at the beginning of this manual.

### Tools and Supplies Needed

- T-30 Torx screwdriver
- Flat head screwdriver
- Phillips\* (cross head) screwdriver (#1 and #2 bits)
- Adequate ESD protective gear (wrist strap, ESD mat)

### System Reference

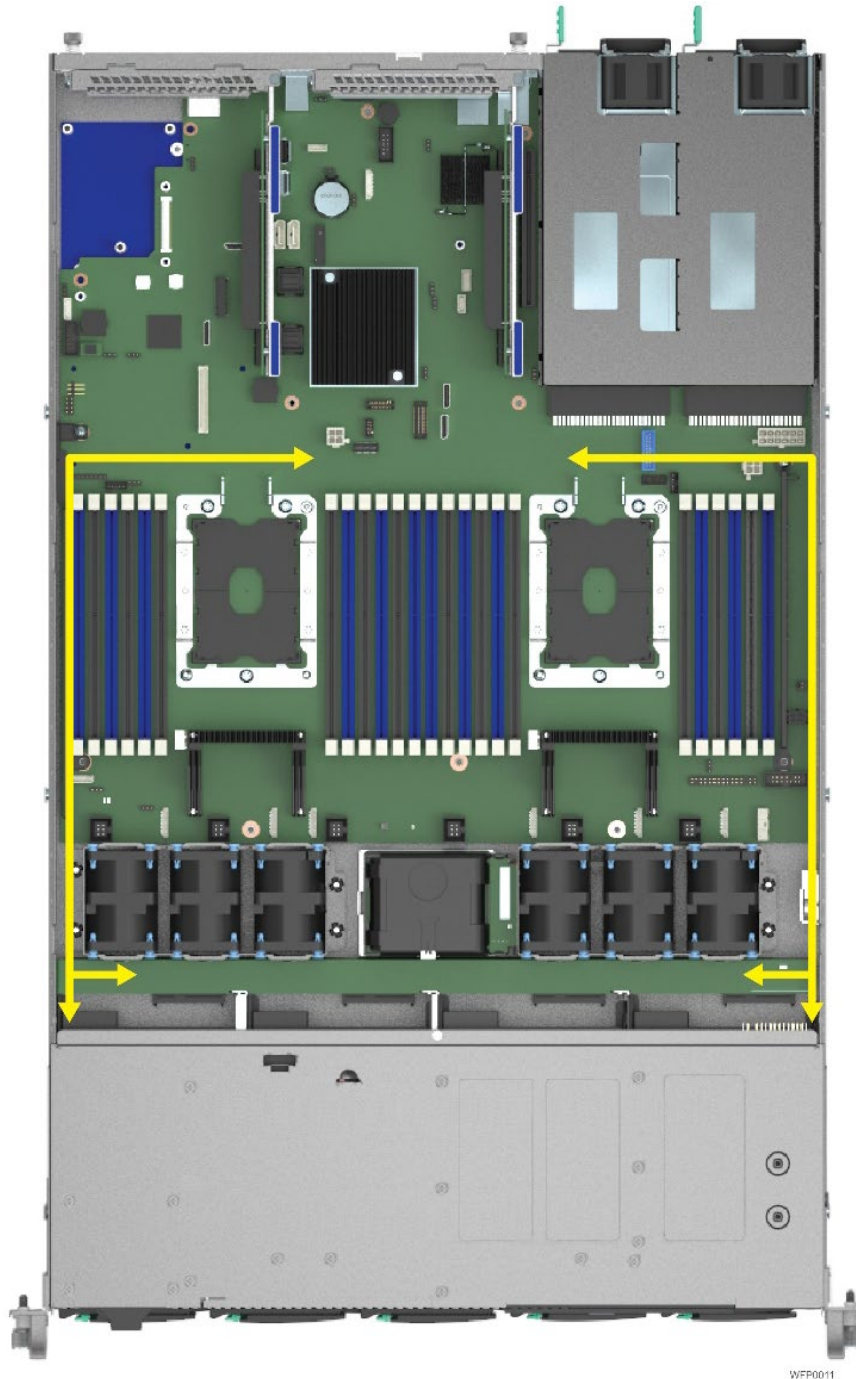
All references to left, right, front, top, and bottom assume the reader is facing the front of the chassis.

### Instruction Format

Each procedure described in this section will follow an illustration first format. This format will give the reader the option to follow a quicker path to system integration by first seeing an illustration of the intended procedure. If necessary, the reader can then follow the step-by-step instructions that will accompany each procedure.

## 2.1 Internal Cable Routing Channels

All cables should be routed using the cable channels along each chassis sidewall as shown in the following illustration. When routing cables front-to-back, none should be routed through the center of the system or in the area between the system fans and the DIMMs slots.



WFP0011

**Figure 20. Internal Cable Routing**



## 2.2 System Cover Removal / Installation

### 2.2.1 System Cover Removal

The server system must be operated with the system cover in place to ensure proper cooling. The cover must be removed to add or replace components inside of the system. Before removing the system cover, power off the system and unplug all peripheral devices and power cable(s).

---

**Note:** A non-skid surface or a stop behind the server system may be needed to prevent the server system from sliding on your work surface. A screw driver may be needed to loosen the system cover thumb screws.

---



**Figure 21. System Cover Removal**

1. Loosen the two captive thumb screws located on the back edge of the system cover (See Letter "A").
2. Slide cover back and lift upward (see Letter "B").

### 2.2.2 System Cover Installation



WFP0030

**Figure 22. System Cover Installation**

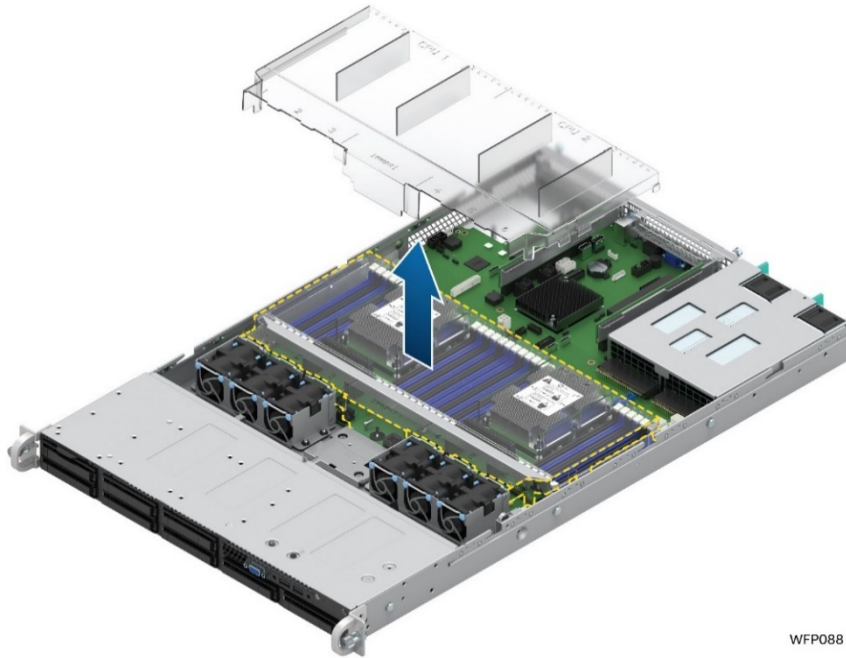
1. Place the system cover onto the chassis and slide forward until the front edge of the system cover is pressed up against the back edge of the front drive bay. (See Letter "A").
2. Hand tighten the two captive thumb screws at the back of the chassis (see Letter "B").

**Note:** For safety after performing service inside of the system, the top cover must be reinstalled and the thumbscrews tightened to 8in/lb torque or to where the use of a tool is required to re-enter the server.

## 2.3 Air Duct Removal / Installation

Always operate your server system with the air duct in place. The air duct is required for proper airflow within the server system.

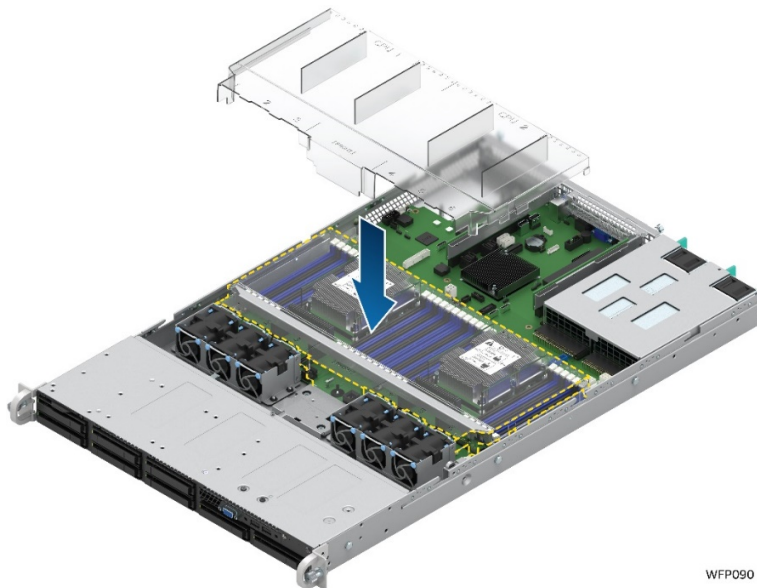
### 2.3.1 Air Duct Removal



WFP088

Figure 23. Air Duct Removal

### 2.3.2 Air Duct Installation



WFP090

Figure 24. Air Duct Installation

Position the air duct behind the system fans and over the processors and memory and carefully lower it into place. If placed correctly, the air duct should sit flat and securely in place.

## 2.4 Processor Assembly, Installation, and Replacement

### Components Required:

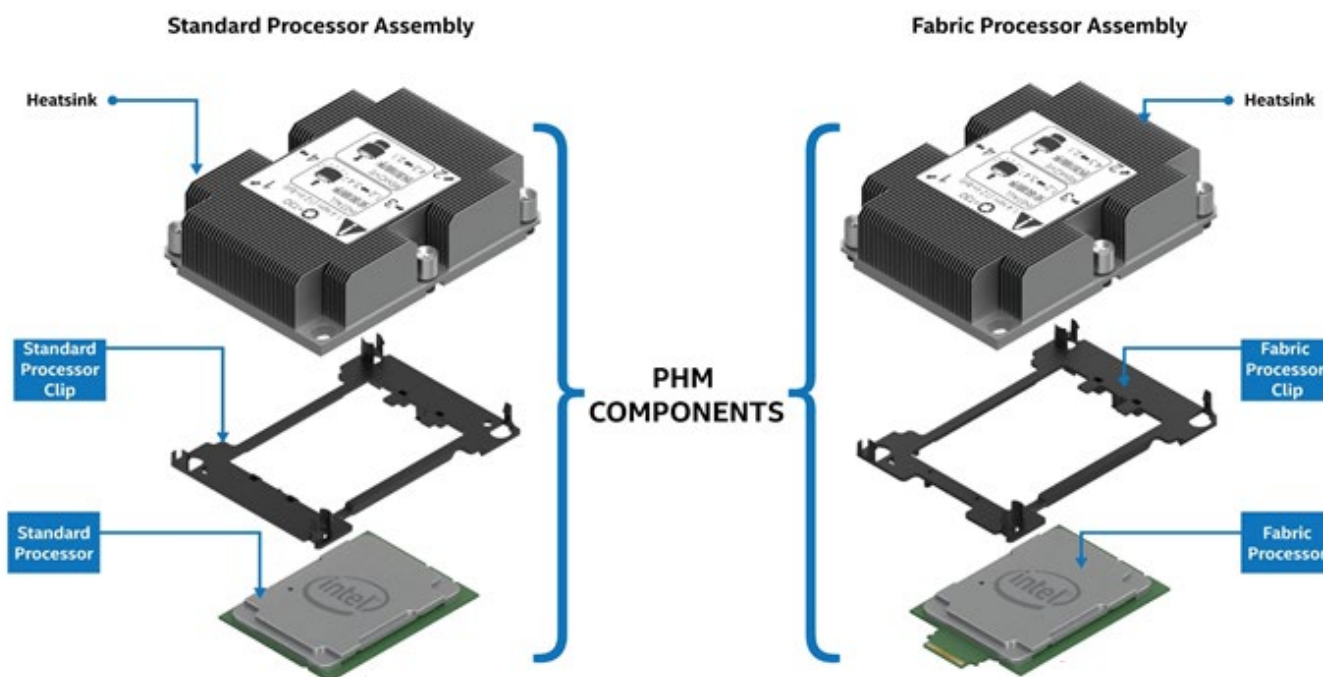
- 1 or 2 1st or 2nd Gen Intel® Xeon® processor Scalable family
- 1 or 2 processor clips – Standard and/or Fabric
- 2 Processor Heat Sink(s)

To upgrade to the 2<sup>nd</sup> Gen Intel® Xeon® processor Scalable family, first update the system software stack from the following Intel® website: <https://downloadcenter.intel.com>.

### Tools Required:

- T-30 Torx screwdriver
- Flat head screwdriver
- Adequate ESD protective gear (wrist strap, ESD mat)

This generation of Intel Server Systems requires that the processor be attached to the heat sink prior to installation on to the server board. The processor / heat sink assembly is referred to as the processor heat sink module, or PHM.



**Figure 25. Processor Heat Sink Module (PHM) Reference Diagram**

To properly assemble the PHM and install it to the server board, the procedures described in the following sections must be followed in the order specified. These instructions assume that all the PHM components are new and the Thermal Interface Material (TIM) is already applied to the bottom of the heat sink.

**Note:** Intel Server Systems include two processor carrier clips to support standard Intel® Xeon processors. For Intel® Xeon® processors that include an Intel® Omni-path host interface connector, a Fabric processor clip must be used in place of the standard processor clip. Fabric processor clips are included with the following Intel Fabric processor accessory kits: **AWF1PFABKITM** or **AWF1PFABKITP**

**WARNING:** Attempting to use a Standard processor clip with a Fabric supported processor may result in component damage and/or induce improper assembly of the PHM.

## 2.4.1 PHM Assembly

1. Remove the heat sink from its packaging. To avoid damage to the heat sink, grasp it by its narrower, top and bottom edges, as shown below.

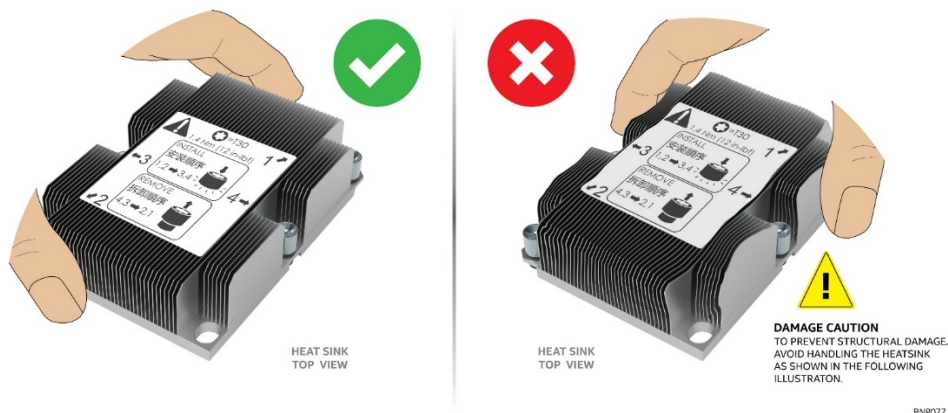


Figure 26. Processor Heat Sink Handling

2. Place the heat, sink bottom side up, on to a flat surface as shown.

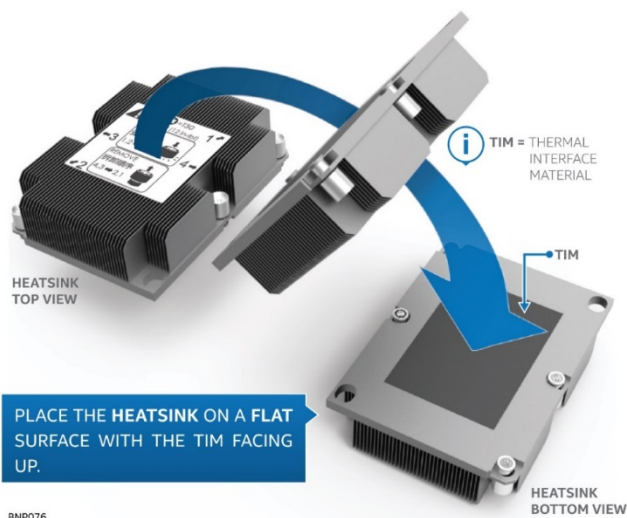
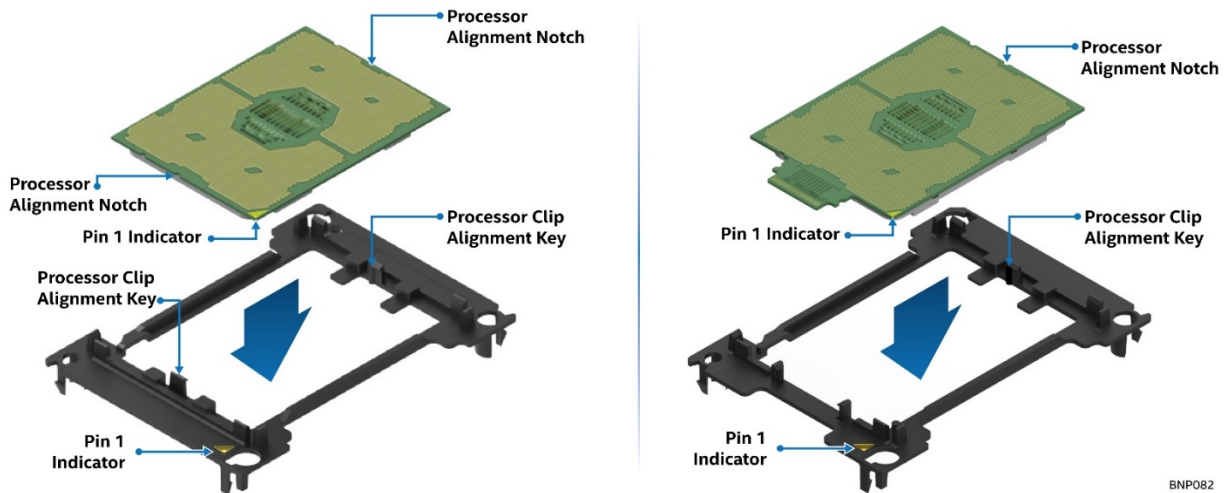


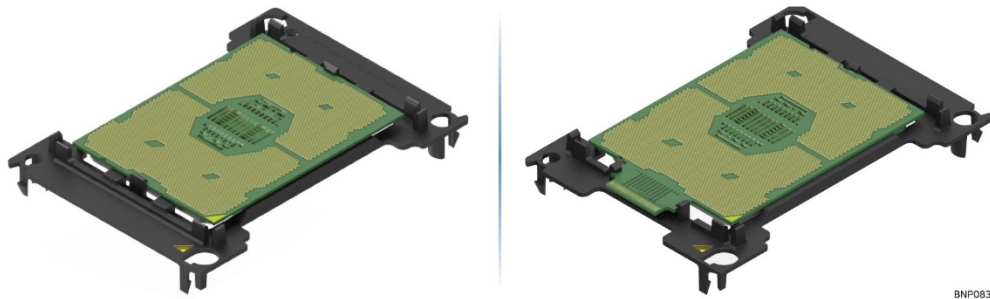
Figure 27. PHM Assembly – Heat Sink Orientation

3. If present, carefully remove the plastic protective cover from the bottom side of the processor to expose the Thermal Interface Material (TIM)
4. Locate the processor clip and place it on to a flat non-skid surface with corner latch pins facing down
5. Carefully remove the processor from its packaging. **A processor should only be grasped by its edges. Do not touch any part of the component side of the processor with your fingers.**



**Figure 28. Processor Clip Assembly**

6. Orient the processor, component side up, so that all alignment features match those of the carrier clip as shown in the following figures.



**Figure 29. Processor Clip Sub-Assembly**

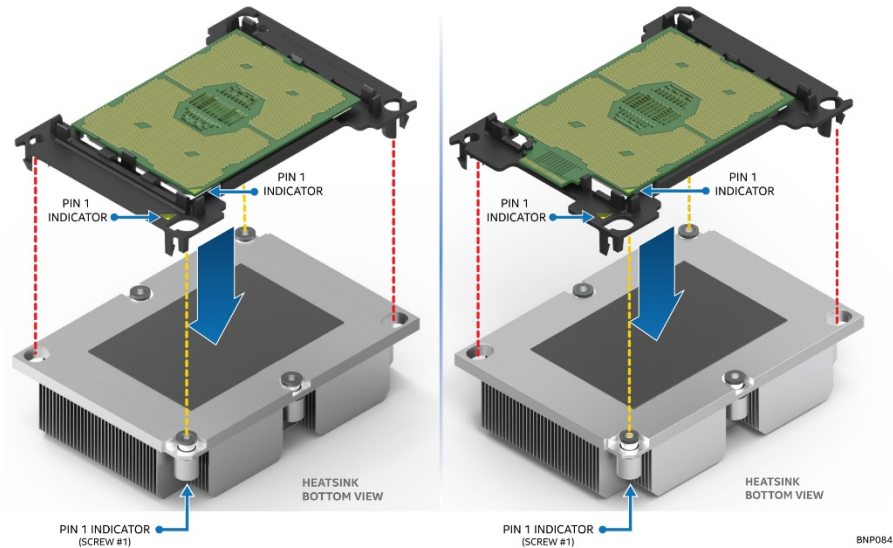
7. Install the processor into the processor clip until it snaps into place.

---

**CAUTION:** To prevent the processor from falling out of the clip, the processor clip assembly should only be grasped by its shorter edges.

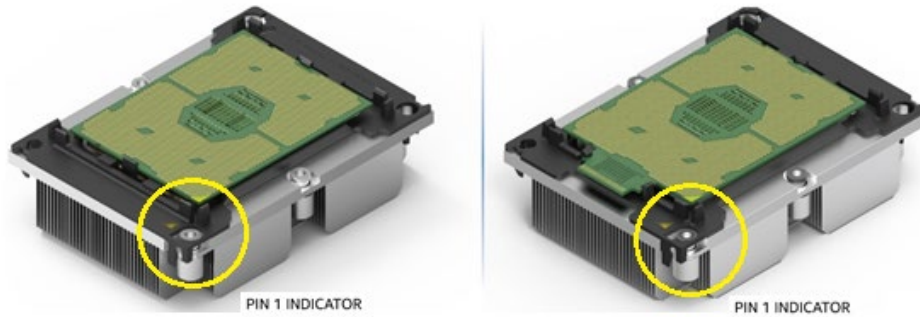
**CAUTION:** Do not touch the sensitive contacts on the bottom side of the processor at any time during PHM assembly or installation. In addition, the pins inside the processor socket are extremely sensitive. A damaged processor socket may produce unpredictable system errors

---



**Figure 30. Processor Clip Sub-assembly to Heat Sink Orientation**

8. Orient the processor clip sub-assembly over the processor heat sink so that all corner features are in alignment. **Ensure Pin 1 indicators are aligned** as shown in the following figures.

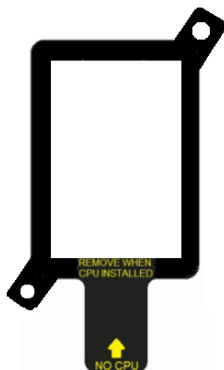


**Figure 31. Processor Heat Sink Module (PHM)**

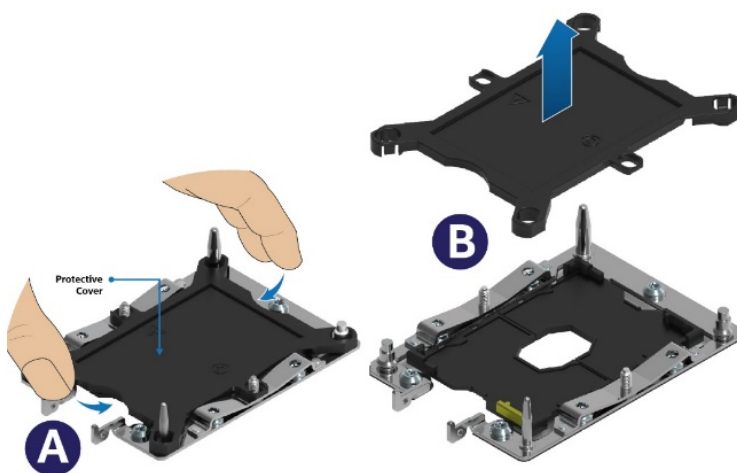
9. Push the processor clip sub-assembly down on to the processor heat sink until it snaps into place, ensuring all four corners are secure. Processor clip sub assembly should sit flat on top of the heat sink.

## 2.4.2 Processor Installation

Intel server systems support the installation of 1 or 2 processors. For the server to be operational, CPU #1 must be installed. The installation of CPU #2 is optional, however, to ensure proper airflow when the server system is operational, the CPU #2 heat sink must be installed at all times. When no processor is installed in a socket, one of the provided black Mylar spacers should be installed between the processor heat sink and the processor socket. This is a serviceability feature that identifies that a socket has no processor present when only a heat sink is installed.



1. Remove the plastic cover from the processor socket on the server board



**Figure 32. Plastic processor socket cover removal**

- a) Grasp the processor cover as shown in the following figure (see Letter “A”).
- b) Carefully pull it up away from the processor socket, ensuring no contact is made with any of the pins within the socket. (see Letter “B”).

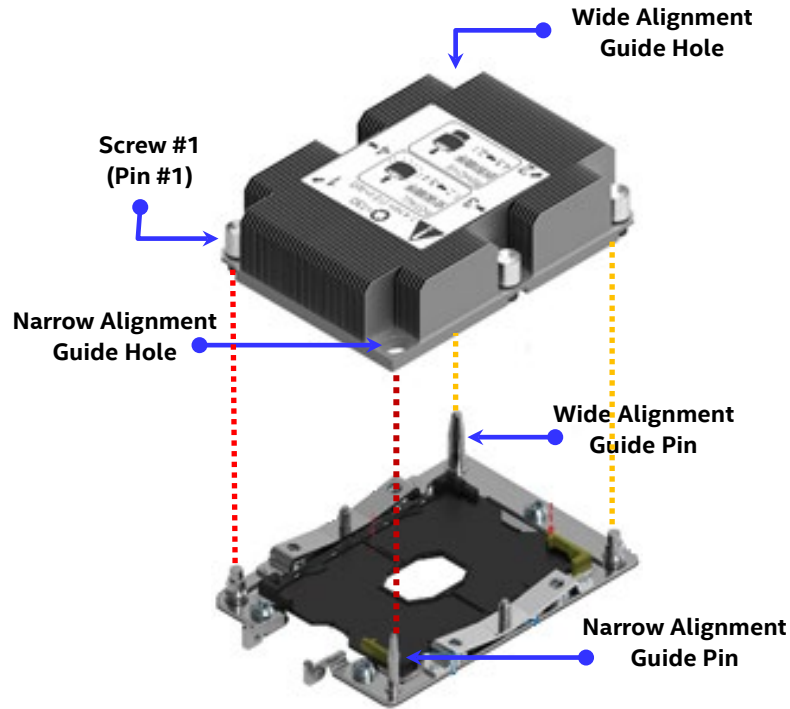
---

**NOTE:** The processor socket cover should be saved for future use.

**CAUTION:** When re-installing the socket cover, make sure it properly snaps into place. Improper installation will cause it to become loose and damage the processor socket.

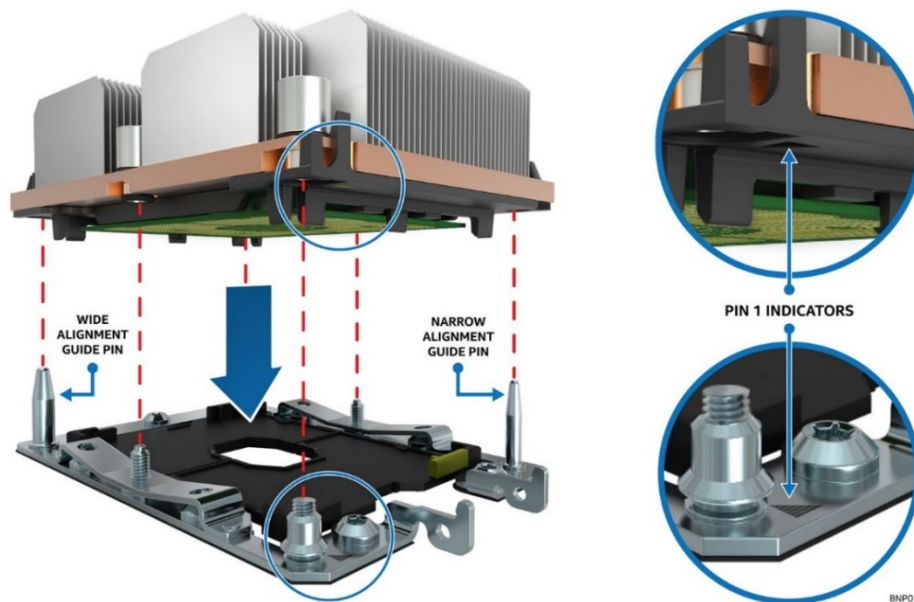
---

The assembled PHM and the processor socket include several alignment features to ensure the PHM can only be installed one way. Care should be taken to ensure components are accurately assembled and the PHM is oriented correctly to the processor socket prior to placement onto the server board.



**Figure 33. Alignment Features**

2. Install PHM assembly to the processor socket on the server board



**Figure 34. PHM Alignment to Bolster Plate**

c) Align the mounting holes of the PHM (located on diagonal corners) to the guide pins of the processor socket as shown in the following figure.

3. Lower the PHM onto the processor socket assembly.

---

**CAUTION:** Processor socket pins are delicate and bend easily. Use extreme care when placing the PHM onto the processor socket, do not drop it.

---



- d) The PHM assembly is properly installed when seated flat and evenly upon the processor socket assembly.



**Figure 35. Correct PHM Placement**

---

**NOTE:** The PHM is NOT installed properly if it does not sit level with the processor socket assembly. Improperly installed PHMs cannot be fastened down. PHMs can only be fastened down if correctly installed.

---

4. Secure PHM to the processor socket assembly



**Figure 36. Installing the PHM**

- e) Using a T30 Torx bit screwdriver, securely tighten (12 in-lb) each fastener in the sequence shown on the label located on the top of the heat sink.

---

**CAUTION:** Failure to tighten the heat sink screws in the specified order may cause damage to the processor socket assembly. Each heat sink screw should be fully tightened to 12 in-lb torque before securing the next screw in the sequence.

---

5. For a second processor, repeat the processor installation instructions above, ensuring the proper processor heatsink and processor carrier clip are used for the installation.

For single processor configurations where a 2<sup>nd</sup> processor is not configured, install the CPU#2 heat on to the CPU #2 socket to ensure proper air flow when the system is operational.

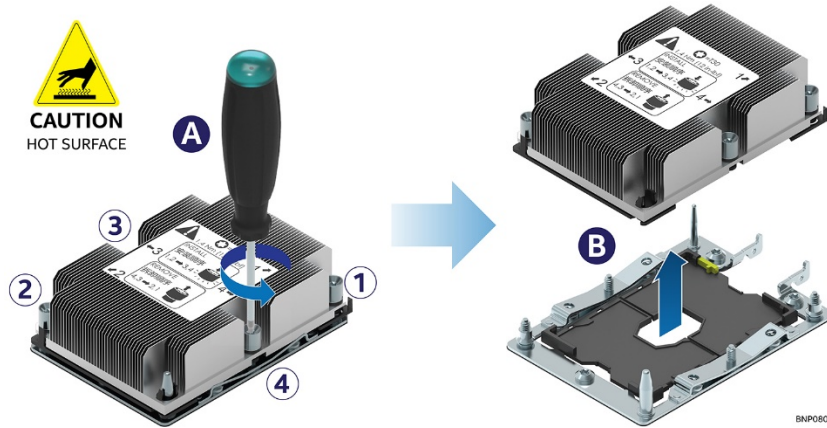
See Section 3.10 for installation instructions related to fabric processor accessory kits.

### 2.4.3 Processor Replacement

#### 1. Remove Processor from Server Board

**WARNING:** Processor heat sinks can become extremely hot during normal system operation. Before attempting to remove the processor from the server board, allow the processor heat sinks to fully cool.

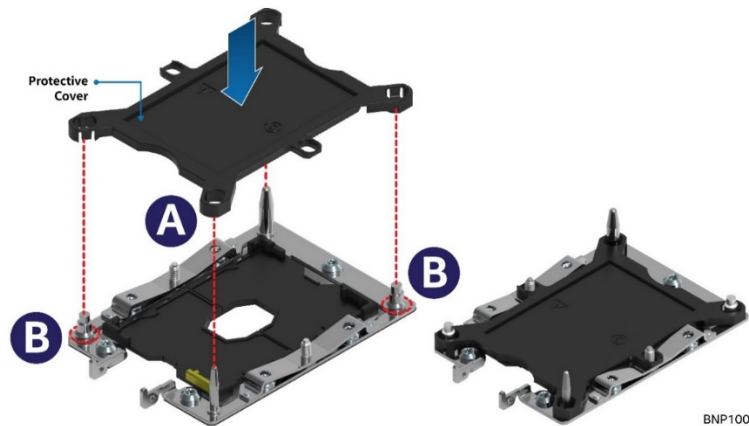
**Failing to follow the indicated disassembly sequence, may cause damage.**



**Figure 37. Uninstalling the PHM**

- a) Using a T30 Torx bit screwdriver, loosen each heat sink fastener in the sequence shown on the label located on the top of the heat sink (see Letter “A”).
- b) Lift the PHM straight up from the server board until it is free from the processor socket bolster plate guide pins (see Letter “B”).

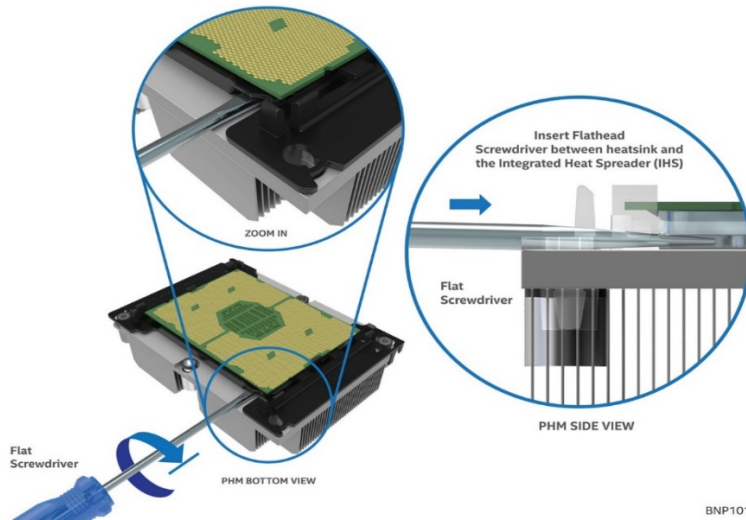
**Note:** to prevent possible damage to the processor socket, re-install the original plastic cover to the processor socket.



**Figure 38. Plastic Processor Socket Cover Installation**

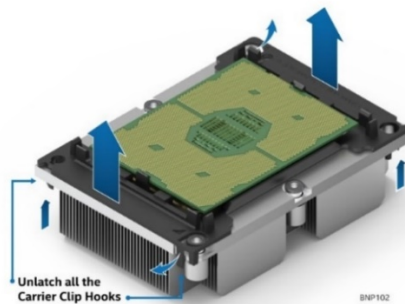
2. With the heat sink facing down, place the Processor Heat Sink Module (PHM) onto a flat non-conductive surface.

3. Remove the processor clip sub-assembly from the heat sink:



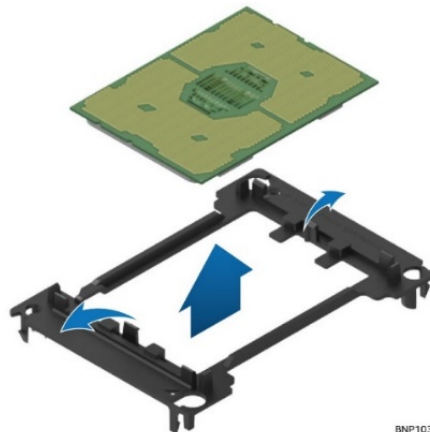
**Figure 39. PHM Disassembly**

- c) Insert the head of a flat head screw driver in-between the heat sink and the processor clip assembly and gently twist until the bond between heat sink and the processor is broken.
- d) Unlatch the hooks on each corner of the processor carrier clip to free the processor carrier from the heat sink.



**Figure 40. Releasing the Processor Carrier Clip from the Heat Sink**

- e) Carefully lift the processor sub-assembly from the heat sink.
- f) Remove the processor from the processor clip by carefully pushing back one of the latches located on the ends of the processor and rotating the processor up and out of the processor carrier clip.



**Figure 41. Releasing Processor from Carrier Clip**

## 2.5 Memory Module (DIMM) Installation and Replacement

### Components Required:

- Up to 24 DDR4 DIMMs

### Tools Required:

- None

### General Memory Population Rules:

Memory channels for each processor are identified as A – F. Each memory channel includes two memory module slots identified as 1 and 2. On the server board, each memory module slot is identified by Processor #, Channel Identifier, and DIMM Slot #.

Examples)

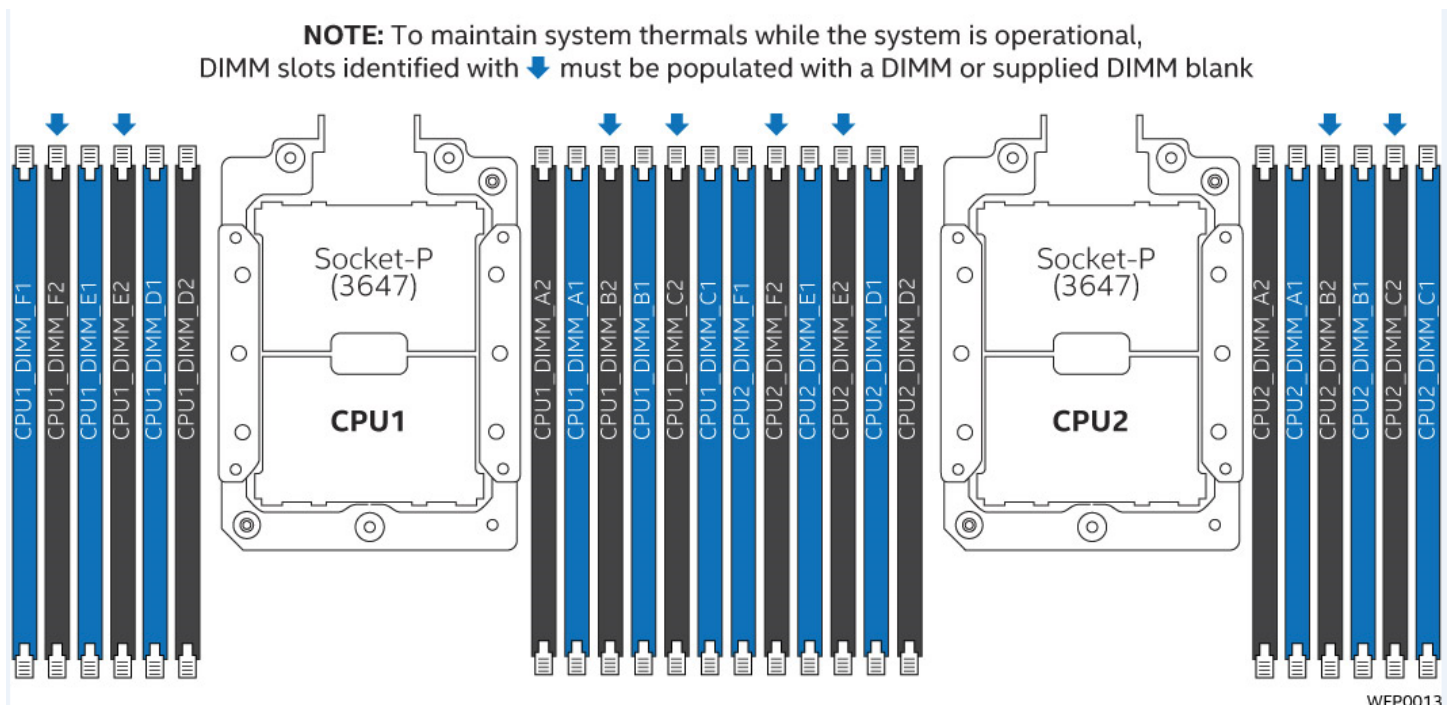
CPU1\_DIMM\_A1  
 CPU1\_DIMM\_A2  
 CPU2\_DIMM\_A1  
 etc.

**BLUE Memory Slots** identify **DIMM 1** for each memory channel.

To maintain required air flow within the system, certain memory slots **MUST** be populated with a DIMM or supplied DIMM blank. DIMM blanks should only be removed when installing a DIMM into the same memory slot.



Figure 42. DIMM Blank



WFP0013

Figure 43. 1U System DIMM Slot Population Requirements for Thermal Compliance

For best performance, DIMMs should be populated using the following guidelines:

- Each installed processor should have matching DIMM configurations
- The following DIMM population guidelines should be followed for each installed processor
  - **1 DIMM to 3 DIMM Configurations** – DIMMs should be populated to DIMM Slot 1 (**Blue Slot**) of Channels **A** thru **C**
  - **4 DIMM Configurations** – DIMMs should be populated to DIMM Slot 1 (**Blue Slot**) of Channels **A**, **B**, **D**, and **E**
  - **5 DIMM Configurations – NOT Recommended.** This is an unbalanced configuration, which will yield less than optimal performance
  - **6 DIMM Configurations** – DIMMs should be populated to DIMM Slot1 (**Blue Slot**) of all Channels
  - **7 DIMM Configurations – NOT Recommended.** This is an unbalanced configuration, which will yield less than optimal performance
  - **8 DIMM Configurations** – DIMMs should be populated to DIMM Slots 1 and 2 of Channels **A**, **B**, **D**, and **E**
  - **9 DIMM, 10, DIMM, and 11 DIMM Configurations - NOT Recommended.** These are unbalanced configurations, which will yield less than optimal performance
  - **12 DIMM Configurations** – DIMMs are populated to ALL DIMM Slots

---

**Note:** DIMM populations noted as “Not Recommended” are fully functional configurations. However, they will not yield the best possible system performance.

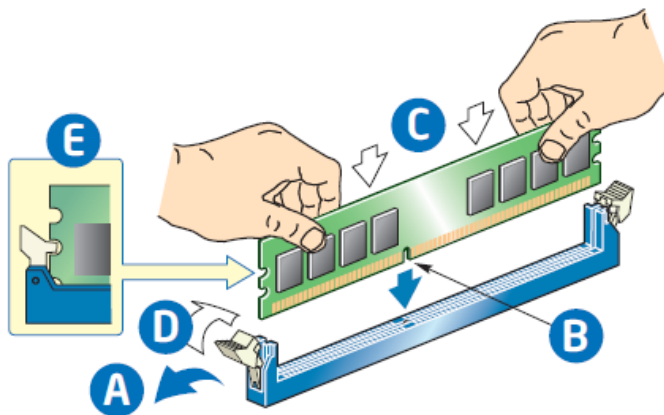
**Note:** For full DIMM population rules that apply only to the Intel® persistent memory module, refer to the *Intel® Server Board S2600WF Product Family Technical Product Specification*.

---

### 2.5.1 DDR4 DIMM Installation

**Note:** Intel® persistent memory module is only supported on server boards and compute modules containing product codes ending in ‘R’ that have the 2<sup>nd</sup> Generation Intel® Xeon® processor Scalable family installed.

---

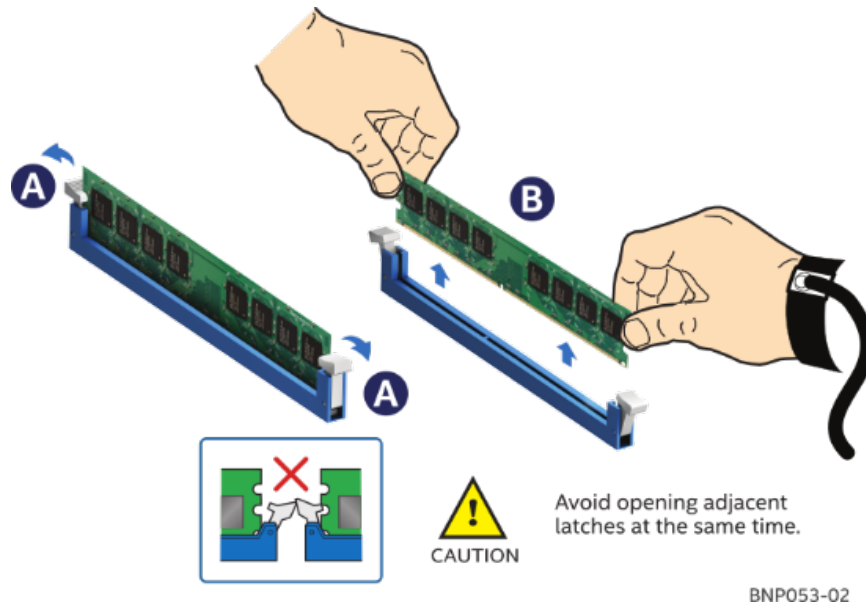


**Figure 44. DDR4 DIMM Installation**

1. Locate the DIMM sockets. Make sure the clips at either end of the DIMM socket(s) are pushed outward to the open position (see Letter “A”).
2. Holding the DIMM by the edges, remove it from its anti-static package. Position the DIMM above the socket. Align the notch on the bottom edge of the DIMM with the key in the DIMM socket (see Letter “B”).
3. Insert the bottom edge of the DIMM into the socket (see Letter “C”).
4. When the DIMM is inserted, push down on the top edge of the DIMM until the retaining clips snap into place (see Letter “D”).
5. Make sure the clips are firmly in place (see Letter “E”).

## 2.5.2 DDR4 DIMM Replacement

1. Locate the DIMM socket for service. Ensure that the retaining clips of adjacent slots are closed.
2. Open the DIMM slot latches at either end of the selected DIMM socket (see Letter “A” in Figure 45). The DIMM will lift from the socket connectors.
3. Holding the DIMM by its edges, lift it away from the socket (see Letter “B”).



**Figure 45. Memory Removal**

For DIMM installation, see Section 2.5.1.

## 2.6 Drive Carrier Extraction, Installation, and Assembly

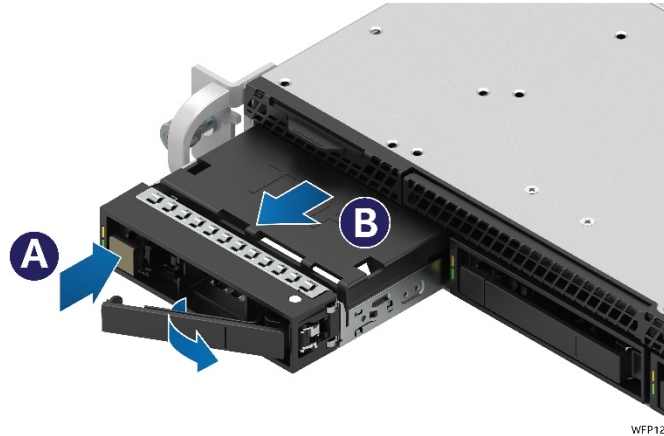
The 1U server product family has front drive bay chassis options that support 2.5" form factor drives (Hard Disk Drives or Solid-State Drives) or 3.5" form factor hard disk drives with the option to support 2.5" SSDs. This section provides instruction for drive extraction from the chassis, drive installation into the chassis, and drive assembly.

---

**Note:** To maintain proper system cooling, all externally accessible drive bays must be populated with a drive carrier. Each drive carrier must have installed a hard disk drive (HDD), Solid State Device (SSD), or a supplied drive blank.

---

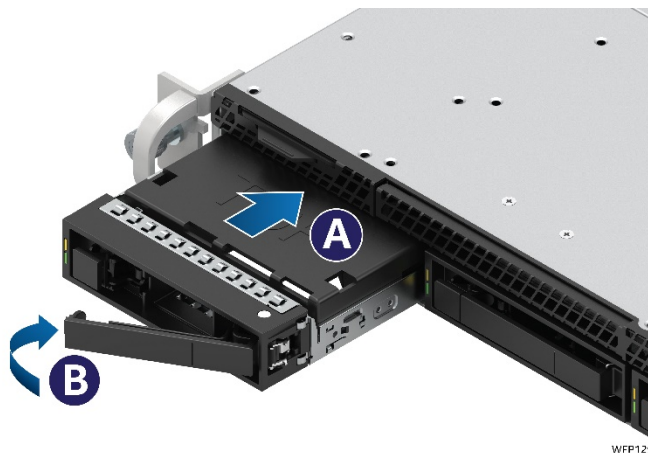
### 2.6.1 Drive Carrier Extraction



**Figure 46. Extracting Drive Carrier from Chassis**

1. Remove the drive carrier from the chassis by first pressing the button on the carrier face plate to release the lever (see Letter "A").
2. Using the lever, pull the carrier from the drive bay (see Letter "B").

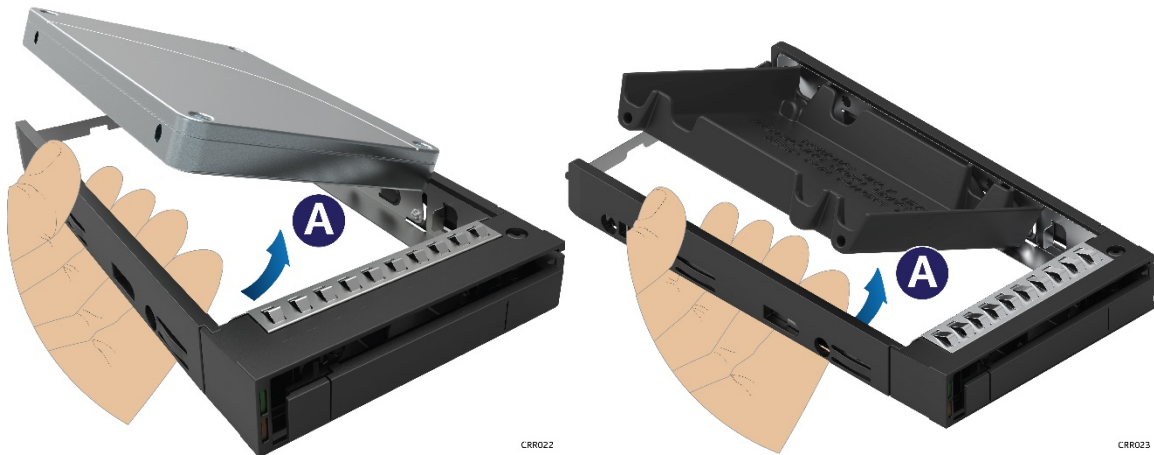
### 2.6.2 Drive Carrier Installation



**Figure 47. Installing Drive Carrier into Chassis**

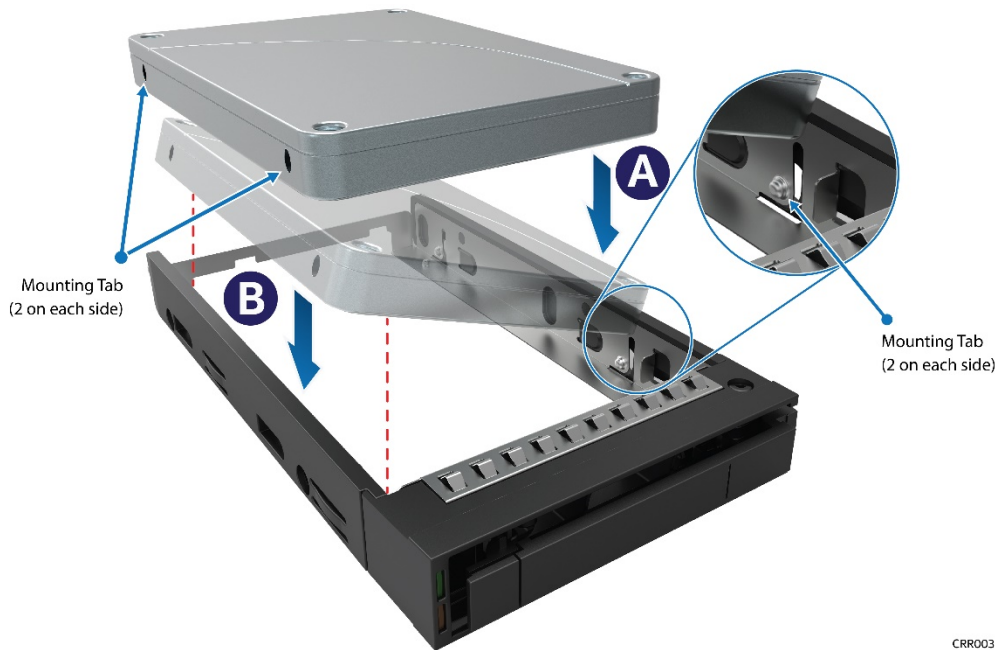
1. Align the drive assembly with the open drive bay.
2. With the lever in the open position, insert the drive assembly into the drive bay (See letter "A") and push forward until the drive makes contact with the backplane.
3. Complete the drive installation by closing the drive assembly lever until it locks into place (See letter "B").

2.6.3 2.5" HDD/SSD Drive Carrier Assembly (Intel® Server System R1208WFxxxx)



**Figure 48. 2.5" Drive Carrier Assembly – Drive / Drive Blank Removal**

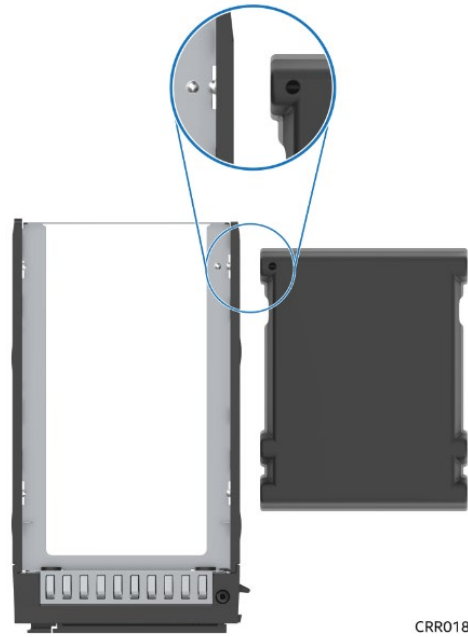
1. Remove the drive or drive blank from the carrier by gently rotating the top edge of a carrier rail outwards while at the same time pushing the drive or drive blank up from the bottom (as shown above).



**Figure 49. 2.5" Drive Carrier Assembly – Drive Installation to Carrier**

2. With the rear drive connector positioned towards the back of the drive carrier, align and position the mounting holes on one side of the drive over the mounting tabs located on the drive carrier side rail (See Letter "A").
3. Lower the other side of the drive into the carrier (See Letter "B") and press down on the drive until all mounting tabs are locked in place.

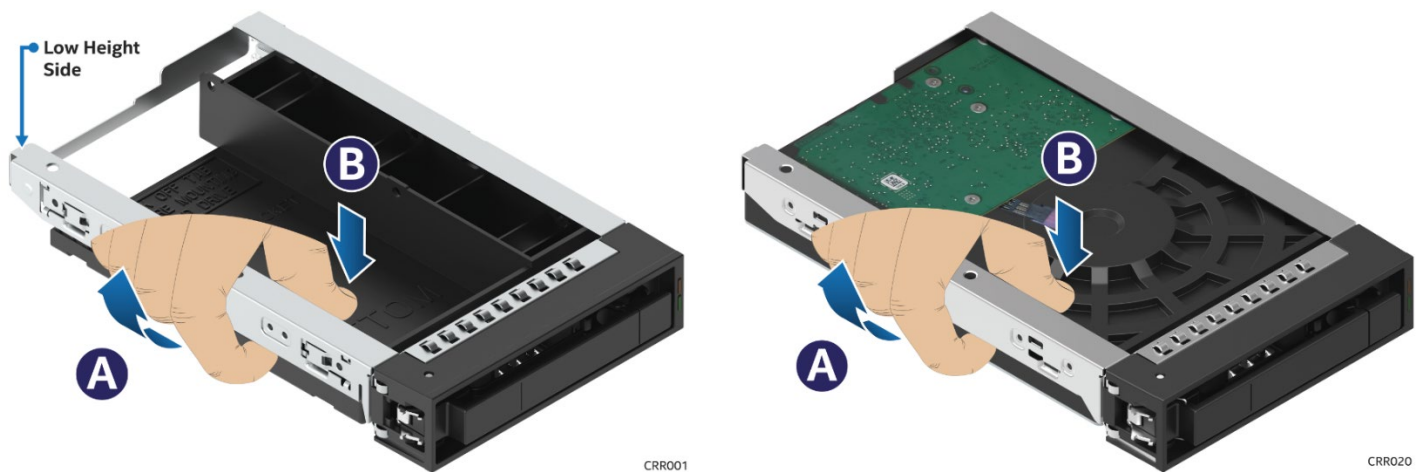




**Figure 50. 2.5" Drive Carrier Assembly – Drive Carrier and Drive Blank Alignment Features**

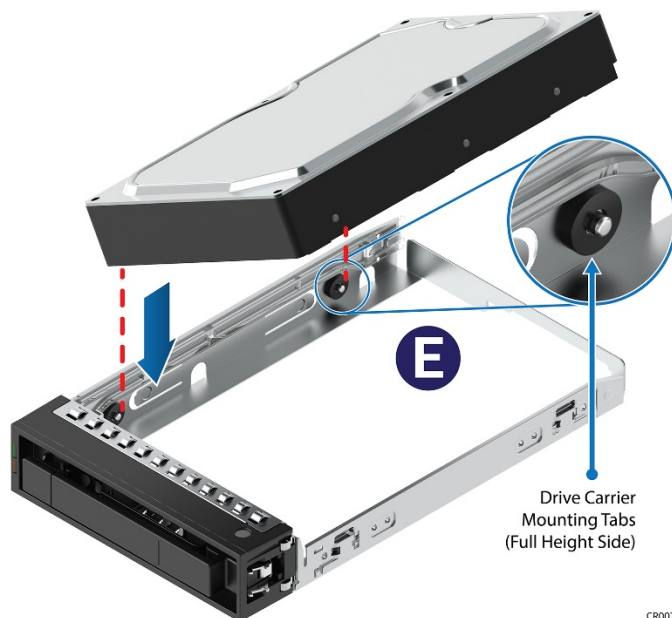
**Note:** The 2.5" drive blank and drive carrier each have an alignment feature (shown above) to ensure proper assembly. When re-installing a drive blank in to the drive carrier, ensure the features are aligned prior to installation. Failure to properly install a drive blank may result with the carrier assembly not fitting properly in to the chassis drive bay.

#### 2.6.4 3.5" HDD/SSD Drive Assembly (Intel® Server R1304WFxxx)



**Figure 51. 3.5" Drive Carrier Assembly - Drive / Drive Blank Removal**

1. Remove the drive or drive blank from the carrier by holding the carrier assembly top side down in your right hand. Using your left hand, gently rotate the bottom edge of the left rail upwards (see Letter "A") while at the same time pushing the drive or drive blank down away from the carrier (see Letter "B").



**Figure 52. 3.5" Drive Carrier Assembly – Drive Installation to Carrier**

2. With the rear drive connector positioned towards the back of the drive carrier, align and position the mounting holes on the left side of the drive over the mounting tabs located on the drive carrier side rail (See Letter "A").
3. Lower the other side of the drive into the carrier and press down until all mounting tabs lock in place.

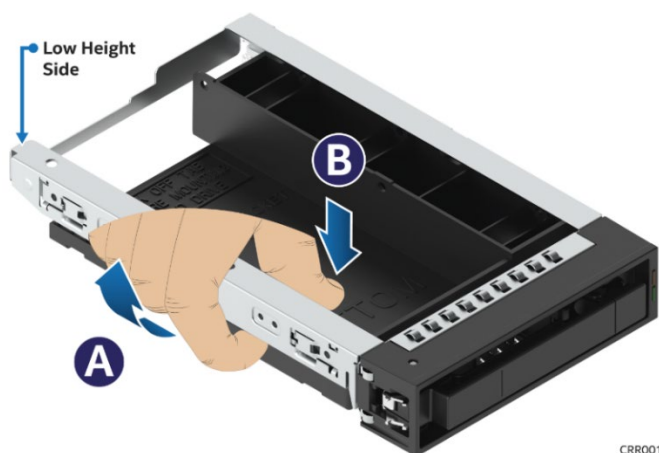
### 2.6.5 2.5" SSD into a 3.5" Drive Carrier Assembly (Intel® Server R1304WFxxx)

The 3.5" drive blank can be used as a 2.5" SSD bracket.

---

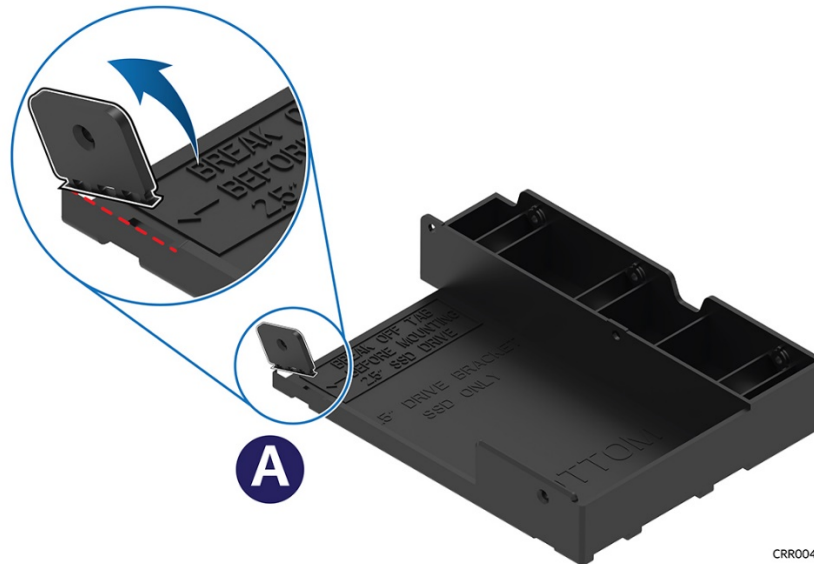
**Note:** Due to degraded performance and reliability concerns, the use of the 3.5" drive blank as a 2.5" drive bracket is intended to support SSD type storage devices only. Installing a 2.5" hard disk drive into the 3.5" drive blank is not supported.

---



**Figure 53. 3.5" Drive Carrier Assembly – Drive Blank Removal**

1. Remove the drive blank from the carrier by holding the carrier assembly top side down in your right hand. Using your left hand, gently rotate the bottom edge of the left rail upwards (see Letter "A") while at the same time pushing the drive blank down away from the carrier (see Letter "B").



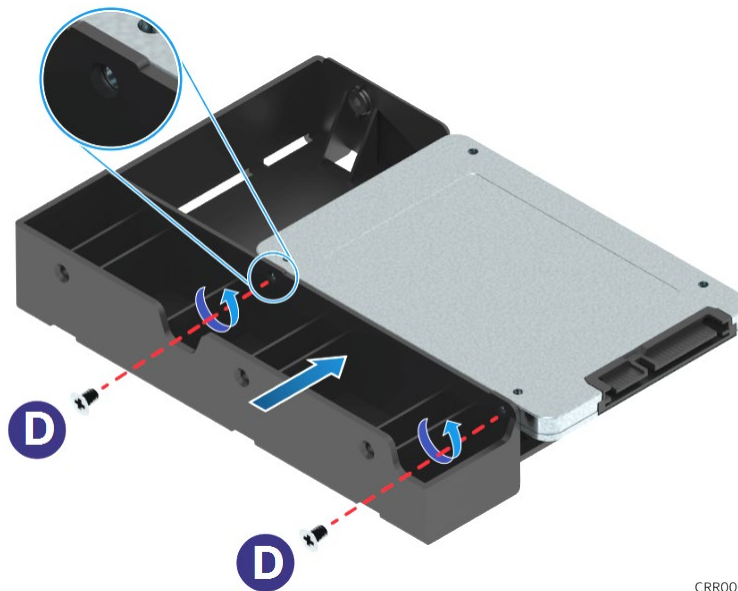
**Figure 54. 3.5" Drive Carrier to 2.5" SSD Bracket – Tab Removal**

2. Break off the small side tab from the side of the drive blank, making the drive blank into a 2.5" drive bracket (see Letter "C").

---

**Note:** Once the side tab is removed, it cannot be re-attached to the drive blank.

---



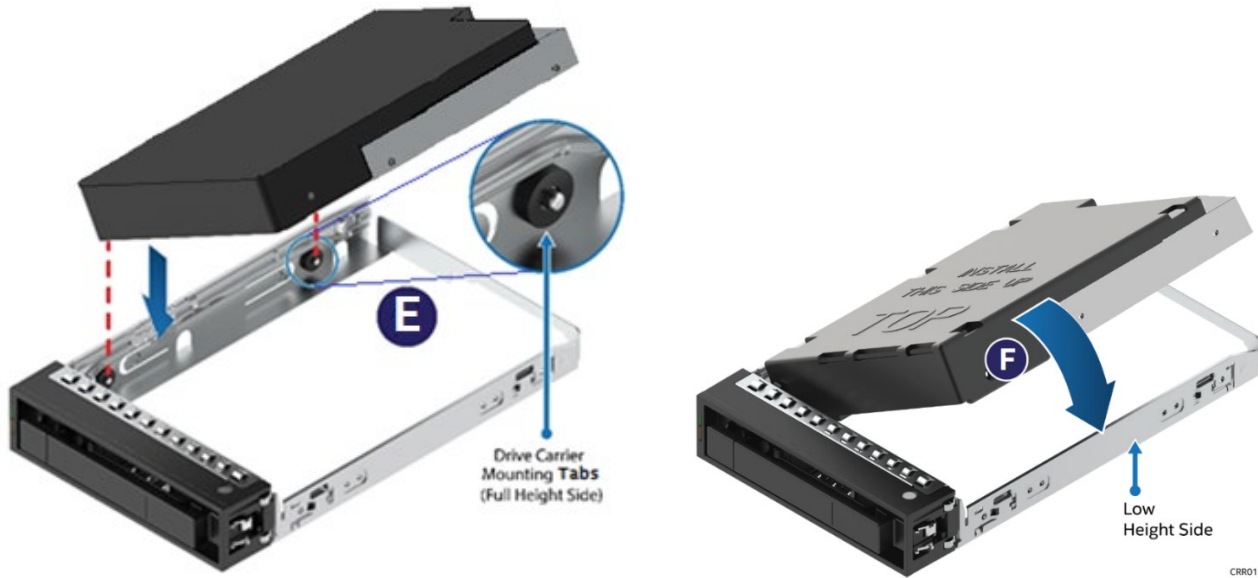
**Figure 55. 3.5" Drive Carrier to 2.5" SSD Bracket – Mount SSD to Bracket**

3. Mount and secure a 2.5" SSD to the drive bracket using two screws at the locations shown above (See Letter "D").

---

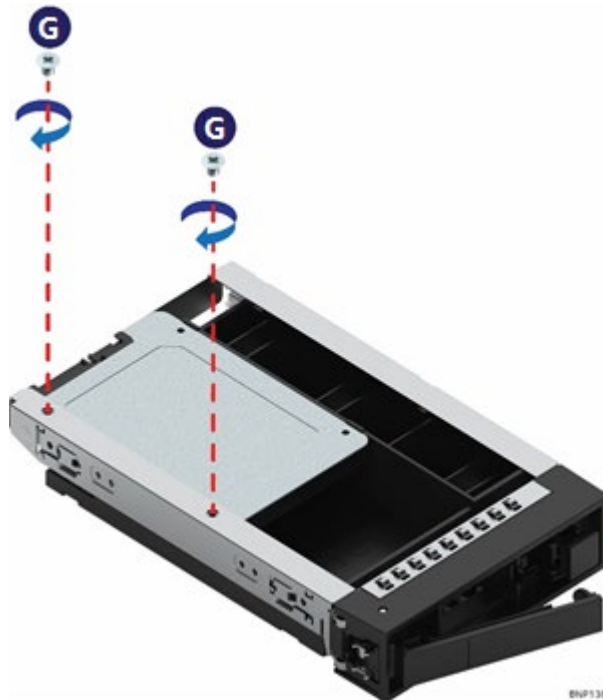
**Note:** New drive carriers with drive blanks installed, will include a bag containing four (4) mounting screws.

---



**Figure 56. 3.5" Drive Carrier to 2.5" SSD Bracket – Mount Bracket Assembly to Carrier**

4. With the rear drive connector positioned towards the back of the drive carrier, align and position the mounting holes on the left side of the drive bracket over the mounting tabs located on the drive carrier side rail (See Letter "E").
5. Lower the other side of the drive into the carrier and press down until all mounting tabs lock in place. (See Letter 'F').
6. Turn the drive assembly over.



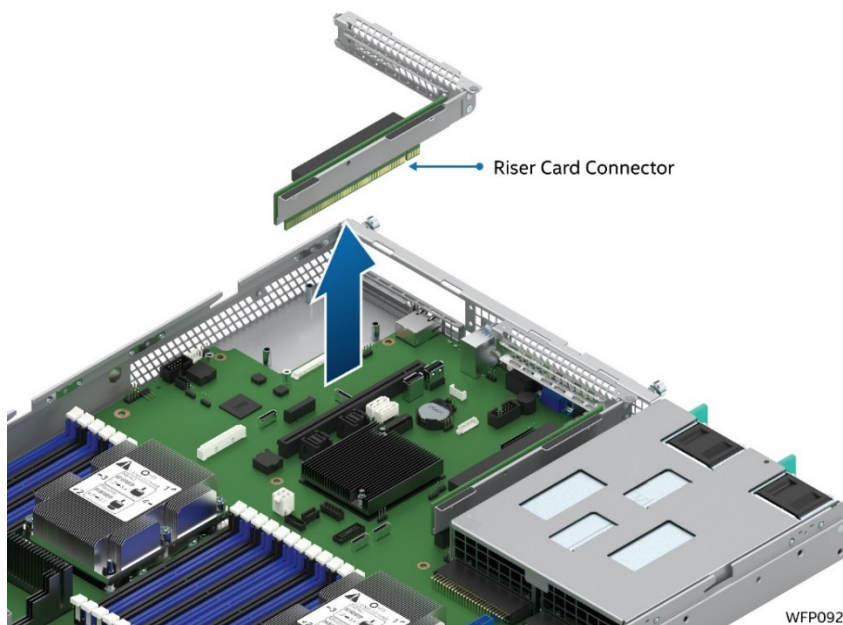
**Figure 57. 3.5" Drive Carrier to 2.5" SSD Bracket – Secure SSD to Carrier**

7. Using two (2) screws, secure the SSD to the carrier side rail (See Letter "G").

## 2.7 Riser Card Bracket Assembly - Removal / Integration / Installation

The server system can support up to two PCIe\* riser cards via the riser card assemblies. This section will provide instructions for the removal and installation of the riser card assemblies from/to the system, and installation of an add-in card into the riser assembly.

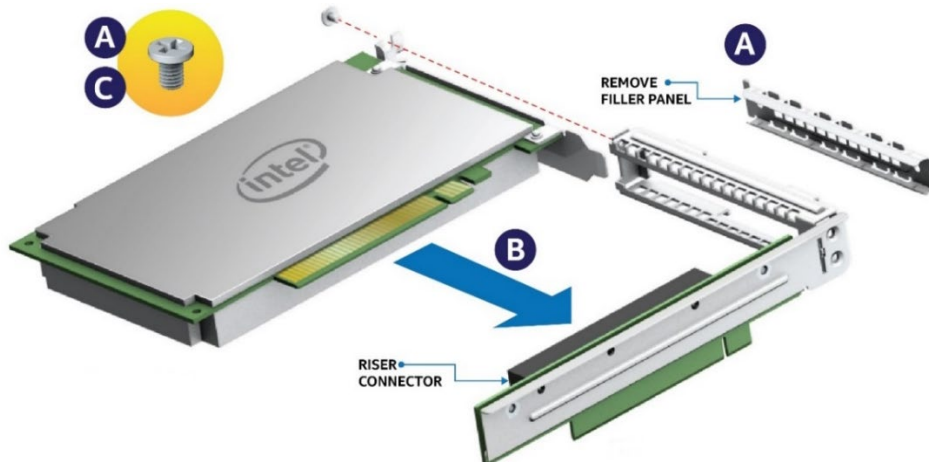
### 2.7.1 Riser Card Bracket Removal



**Figure 58. PCI Riser Assembly Removal**

Disconnect all cables attached to any add-in cards. Grasp the riser assembly with and carefully pull straight up to remove it from the system.

### 2.7.2 PCIe\* Add-in Card Installation



**Figure 59. PCI Add-In Card Installation**

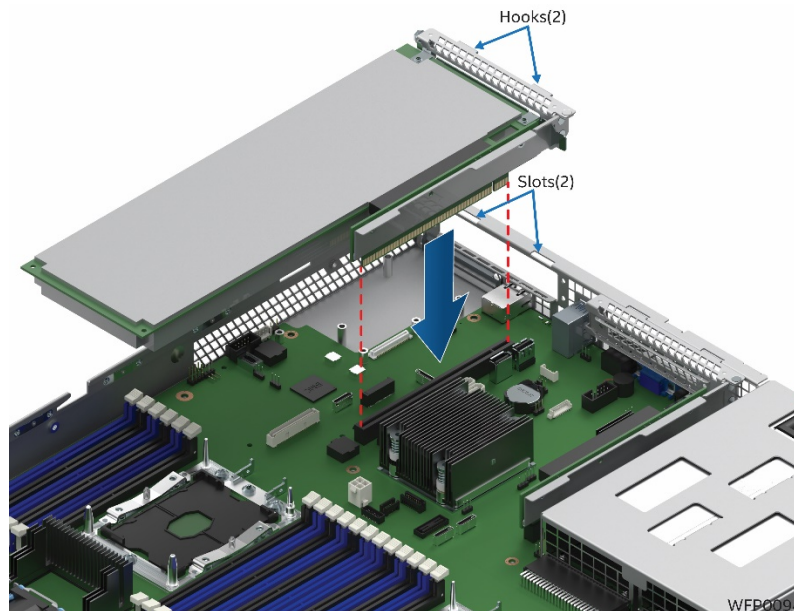
1. Remove the PCI riser assembly from the system (see Section 2.7.1).
2. Remove the filler panel from the add-in card slot and remove the fastener screw as shown (see Letter "A").
3. Insert the add-in card until it is fully seated inside the PCI slot on the riser card (see Letter "B").
4. Secure the add-in card to the riser bracket with the fastener screw as shown (see Letter "C").

### 2.7.3 Riser Card Bracket Installation

---

**Note:** For add-in cards with internal cable connectors, it may be necessary to connect cables before installing the riser card assembly into the system.

---



**Figure 60. Riser Card Bracket Installation**

1. Position the riser card's edge connector over the riser slot on the server board and align the two hooks on the back edge of the riser assembly with the slots on the back of the chassis.
2. Once aligned, press the riser assembly straight down into the riser slot.

---

**Note:** Do not rock the riser assembly into place; doing so may damage the contact pins within the riser slot.

---

## 2.8 PCIe\* NVMe\* SSD Support – (R1208WFxxx only)

The Intel® Server System R1208WF product family has support for up to eight (8) PCIe\* NVMe\* SSDs. Available options to provide the necessary PCIe\* data signals necessary to support each installed NVMe\* drive include:

- Up to Four (4) PCIe\* OCUlink connectors on the server board
- 4-port PCIe\* Switch Add-in Card – Accessory Option

The following sections provide information necessary to correctly cable each PCIe\* option to the backplane and communicate NVMe\* drive population rules and mixed drive support limits when an optional Intel® VROC accessory key is installed to provide support for NVMe\* RAID and drive management features.

### 2.8.1 Onboard PCIe\* OCUlink Connector Cabling

1. Locate the appropriate PCIe\* Data cables (sold separately).

---

**Note:** for cleanest cable routing, the appropriate cable should be routed between the matching IDed PCIe\_SSD connectors on the server board and the backplane.

---

- PCIe\_SSD #0 – 530mm – iPC AXXCBL530CVCR
- PCIe\_SSD #1 – 470mm – iPC AXXCBL470CVCR
- PCIe\_SSD #2 – 800mm – iPC AXXCBL800CVCR
- PCIe\_SSD #3 – 700mm – iPC AXXCBL700CVCR

○ (iPC = Intel Product Code)

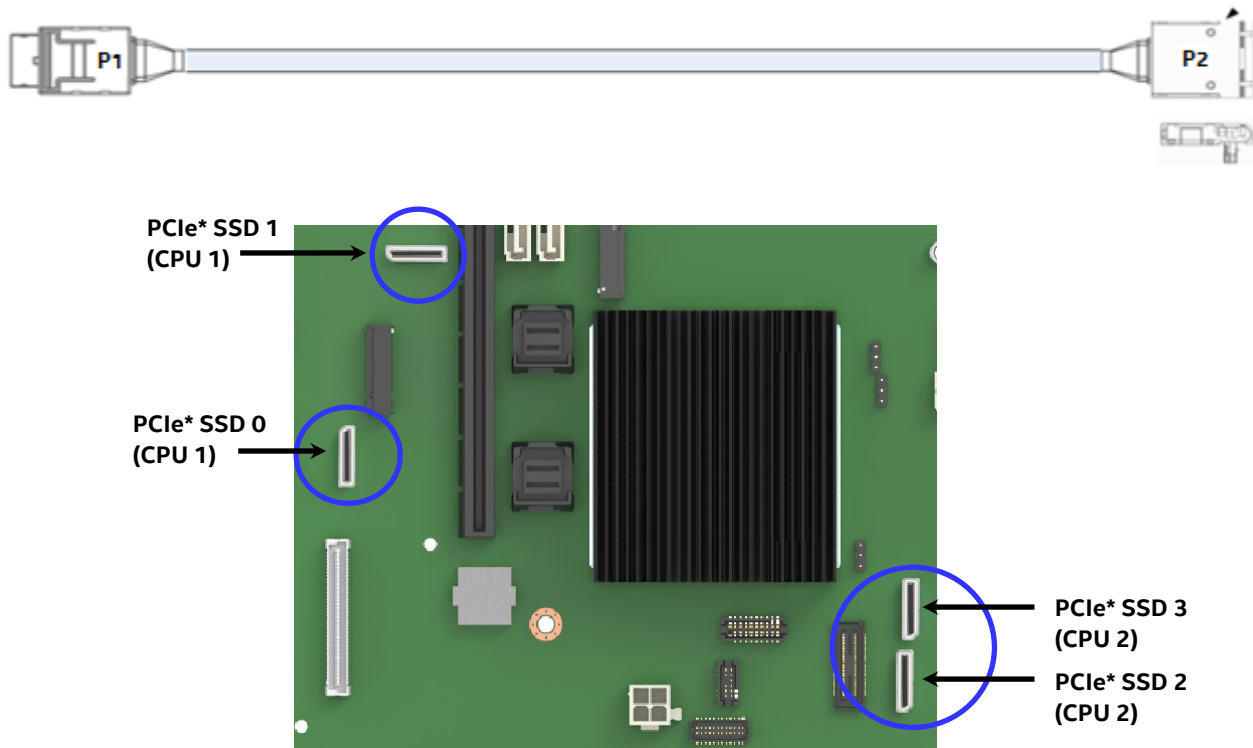
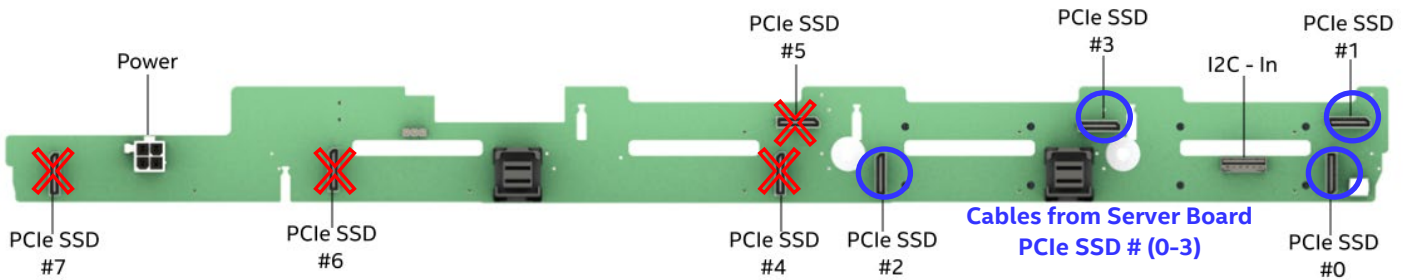


Figure 61. Onboard PCIe\* OCUlink Connectors for NVMe\* SSD Support



**Figure 62. Backplane PCIe\* Data Cable Attachments**

2. Carefully attach the P1 end of the PCIe\* data cable to the PCIe\_SSD OCuLink connector on the backplane
3. Route the PCIe\* data cable along the closest chassis sidewall to the matching onboard PCIe\* OCuLink connector and carefully attach the cable.
4. Repeat steps 2 & 3 for each PCIe\* OCuLink cable to be installed.

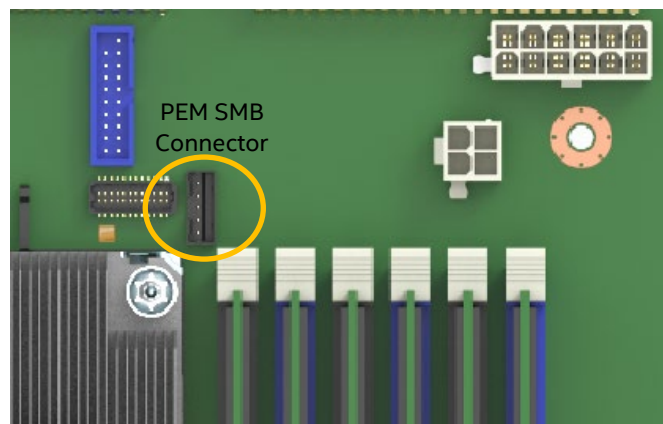
### 2.8.2 4 - Port PCIe\* Switch Cabling

In order to support eight PCIe\* NVMe\* SSDs, a 4-port PCIe\* Switch accessory card and cable kit must be added to the system.

Required Items:

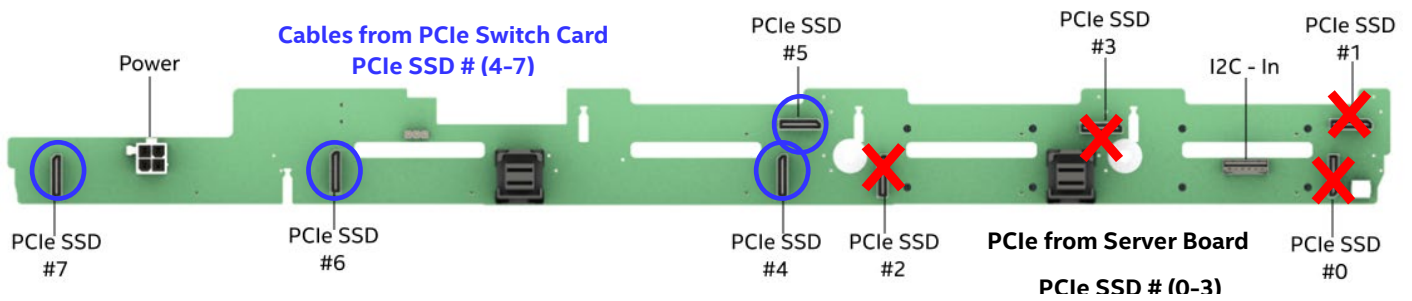
- Intel® Server System R1208WFxxxx
- Intel Accessory **AXXP3SWX08040** – 4-port PCIe\* Switch Add-in Card
- Intel Accessory **TBD** – 4-port PCIe\* Data Cable

1. Remove the Riser Card #2 assembly from the system.
2. Install the PCIe\* Switch card in to the add-in slot on the riser card (See section 2.7.2).
3. Install the 5-pin connector of the PEM cable to the matching 5-pin connector on the PCIe\* Switch card.
4. Attach all four (4) OCuLink cable connectors to the OCuLink connectors on the PCIe\* Switch card.
5. Install the riser card assembly in to the system (See section 2.7.3).



6. Attach the 5-pin PEM cable from the PCIe\* Switch card to the matching 5-pin cable connector ("PEM\_SMB") on the server board.
7. Route the PCIe\* cable from the PCIe\* Switch card along the closest chassis sidewall up to the backplane.





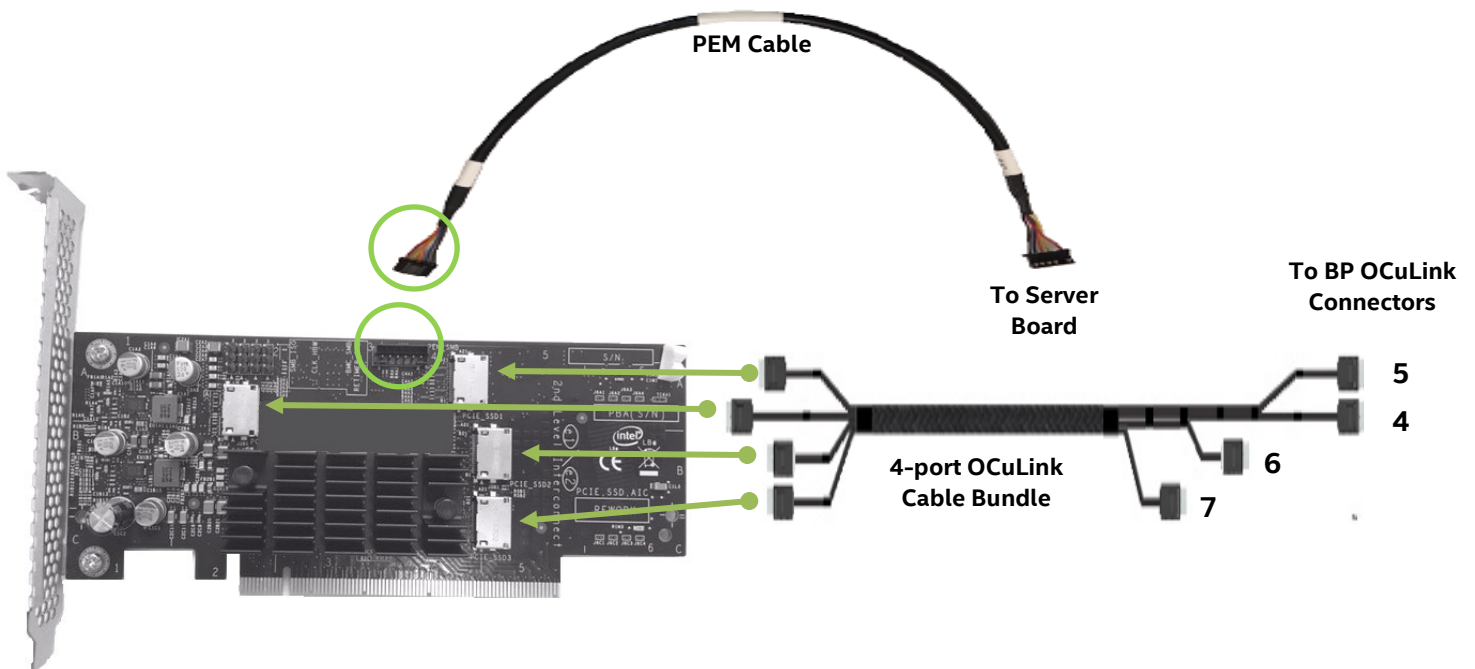
8. Connect the four (4) cable connectors to the PCIe\* OCUlink connectors labeled PCIe\_SSD # (4 – 7) on the backplane.

### 2.8.3 4 - Port PCIe\* Retimer Cabling

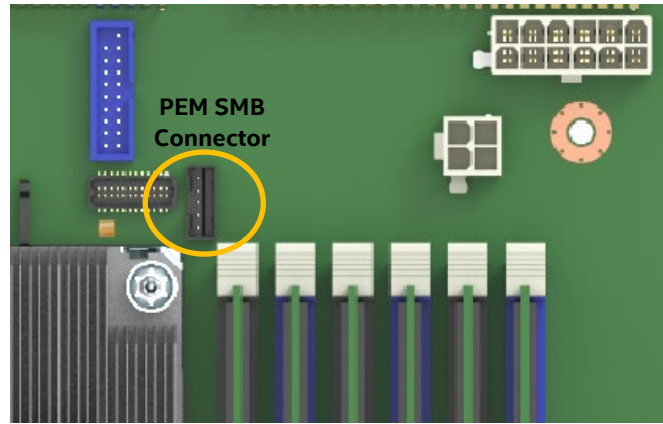
In order to support eight PCIe\* NVMe\* SSDs, a 4-port PCIe\* Retimer accessory card and cable kit must be added to the system.

Required Items:

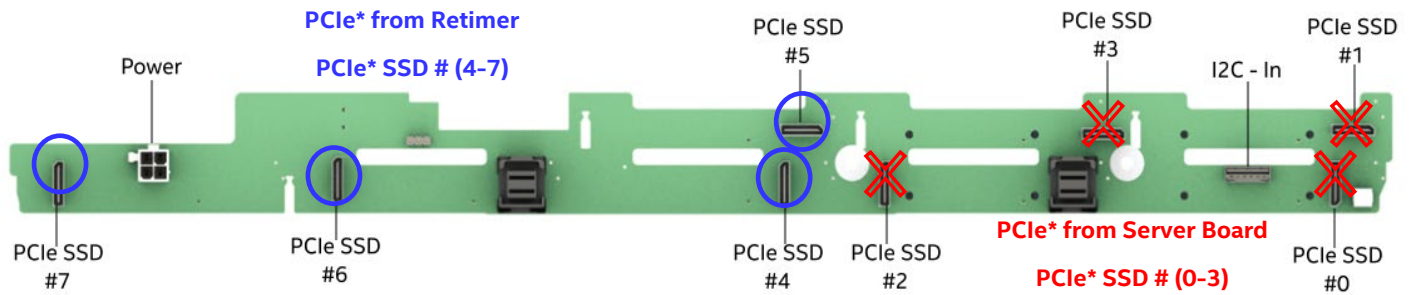
- Intel® Server System R1208WFxxxxx
- Intel Accessory **AXXP3RTX16040** – 4-port PCIe\* Retimer Add-in Card
- Intel Accessory **A1U4PRTCXCXK** – 945mm, Bundled 4-connector PCIe\* OCUlink cable



1. Remove the Riser Card #2 assembly from the system.
2. Install the Retimer card in to the riser card PCIe\* add-in slot (See section 2.7.2).
3. Install the 5-pin connector of the PEM cable to the matching 5-pin connector on the retimer card.
4. Attach 4-port OCUlink Cable Bundle to the matching OCUlink connectors on the retimer card.
5. Install the riser card assembly in to the system (See section 2.7.3).



6. Attach the 5-pin PEM cable from the retimer card to the matching 5-pin cable connector ("PEM\_SMB") on the server board.
7. Route the PCIe\* OCUlink cable bundle from the retimer card along the closest chassis sidewall up to the backplane.



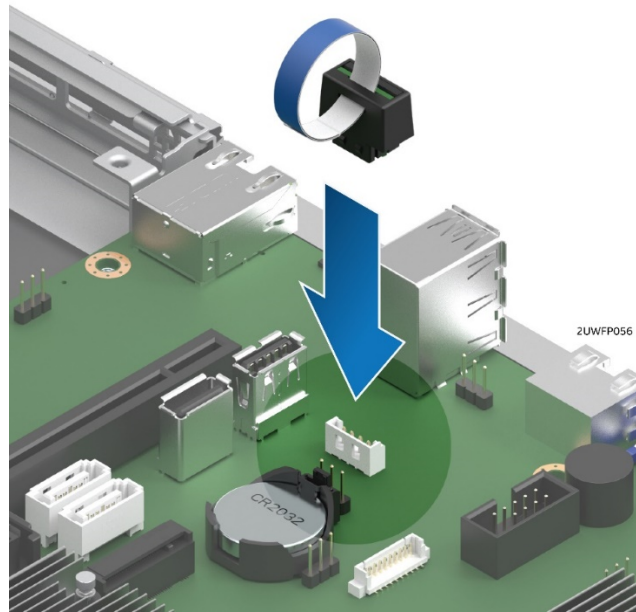
8. Connect the OCUlink cable connectors to OCUlink connectors labeled PCIe\_SSD # (4 – 7) on the backplane

---

**Note:** Retimer card only supports 16x. OS drivers are not required for PCIe\* Switch Add-in cards or PCIe\* Retimer Add-in cards.

---

## 2.8.4 Installing the Intel® VROC Upgrade Key



**Figure 63. Installing the Intel® VROC Upgrade Key**

1. Remove the Intel® VROC Key from its packaging.
2. Locate the white 4-pin key connector above the CR2032 battery on the back edge of the server board.
3. To install the key, place it over the connector and confirm the orientation of the key matches that of the connector.
4. Press the key down onto the connector.

## 2.8.5 Removing the Intel® VROC Upgrade Key

1. Power off the system and disconnect the power cable(s).
2. Remove the system cover (see Section 2.2.1).
3. Using the key pull tab, pull the key up until it disengages from the connector.

## 2.8.6 NVMe\* Drive Population Rules for Intel® VROC

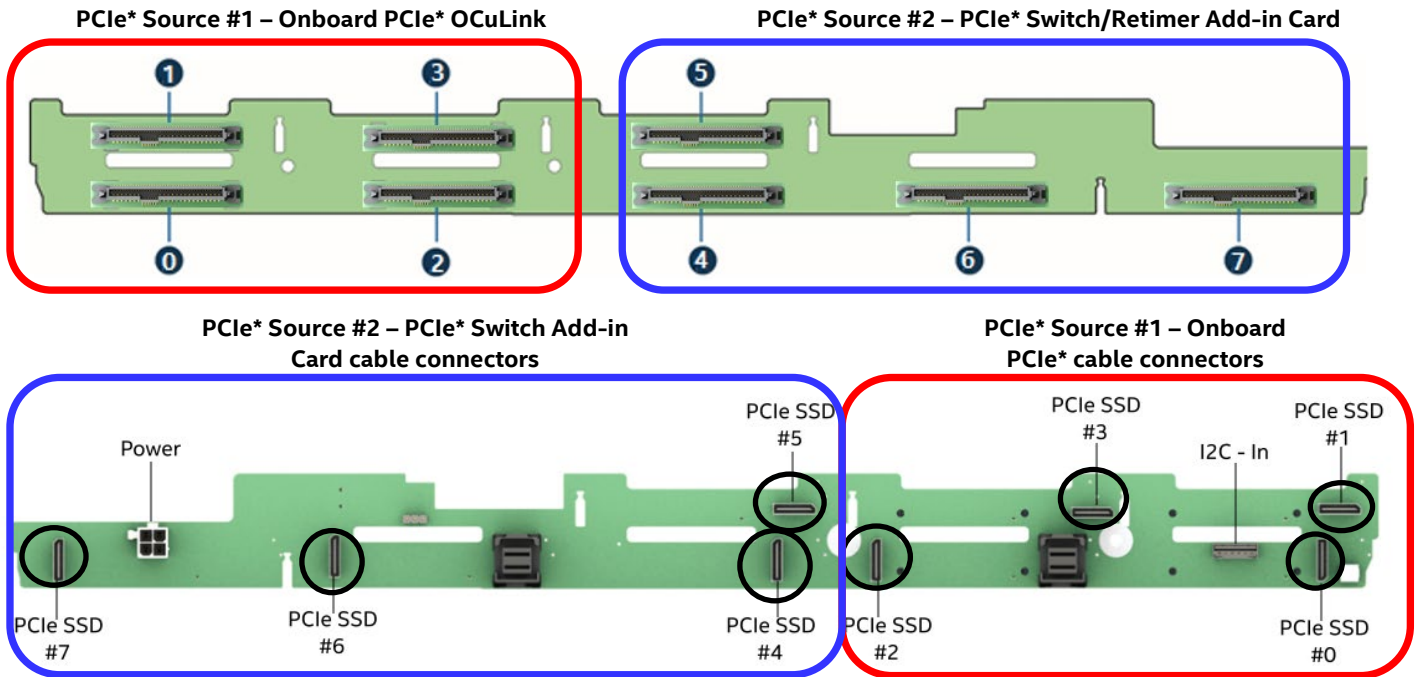
In order to support NVMe\* RAID and NVMe\* Management features, an optional Intel® VROC Key must be installed on to the server board. With the Intel® VROC key installed, specific drive population rules exist and must be followed for proper support of the NVMe\* management features.

The backplane can support PCIe\* data signals from the Server Board PCIe\* OcuLink connectors and/or optional add-in 4-port PCIe\* Retimer card. When cabling the PCIe\* interfaces from two different PCIe\* interface sources to the backplane, the cables from each source must be connected in defined drive sets of four (0,1,2,3) & (4,5,6,7) as shown in the following diagrams.

---

**Note:** The use of one or more OcuLink connectors on the server board to the backplane is considered a single source.

---



**Figure 64. Backplane Cabling from Two PCIe Sources**

When cabling the backplane from two different PCIe sources, no other drive set combinations beyond those defined above are supported.

Drive population rules will differ depending on the source of the PCIe interface to the backplane. In addition, specific drive population limits exist when populating a backplane with both NVMe and SAS drive types.

The following sections define the drive population rules associated with each of the available PCIe sources to the backplane.

---

**Note:** When connecting the backplane to two different PCIe sources, the defined population rules for each PCIe source are applied to the drive set connected to it.

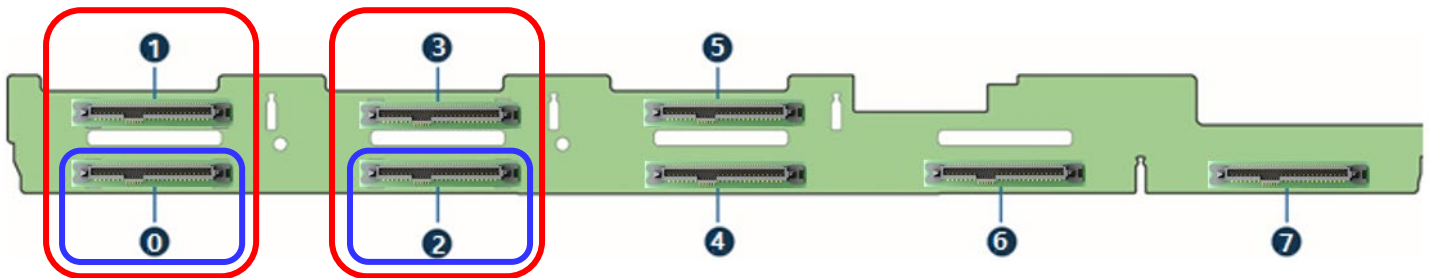
---

### 2.8.6.1 Onboard PCIe\* OCuLink Connectors to 8 x 2.5" Combo Backplane

The following information is applicable when PCIe\* signal to the 8x2.5" combo backplane are cabled from the PCIe\* OCuLink connectors located on the server board.

- NVMe\* drive management sideband signals on the backplane are routed between drive connector pairs: **(0,1) and (2,3)**
- In order to support NVMe\* drive management within a defined drive pair, an NVMe\* drive MUST be populated in the first drive connector of the given pair (drives **0 and 2**)

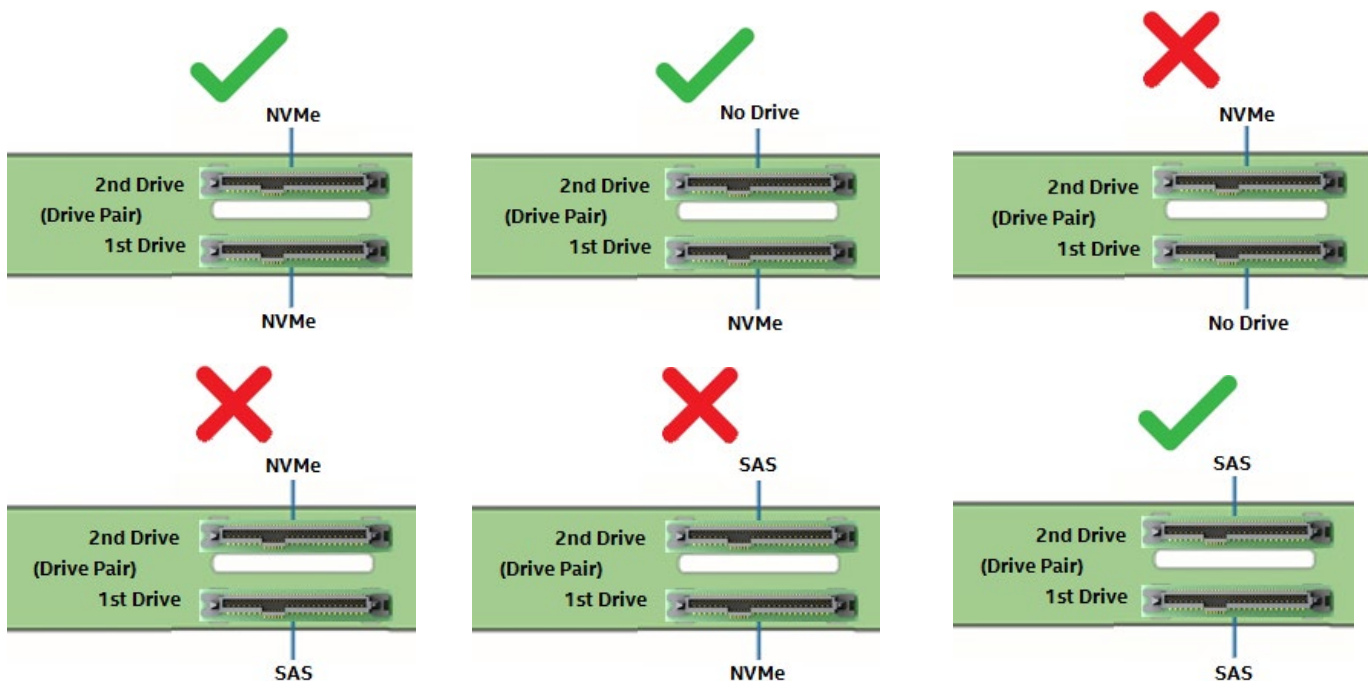
PCIe\* Source Drive Set from Server Board



- Combining an NVMe\* drive with a SAS/SATA drive within a defined drive pair is **NOT** supported.

Example) With an NVMe\* drive installed to drive connector 0, drive connector 1 cannot be populated with a SAS/SATA drive. The same rule applies to ALL other drive pairs on the backplane.

When an Intel® VROC key is installed to the server board, the following illustrations identify supported (✓) and unsupported (✗) drive populations for any defined drive pair when the PCIe\* source to the backplane is cabled from any of the onboard PCIe\* OCuLink connectors.

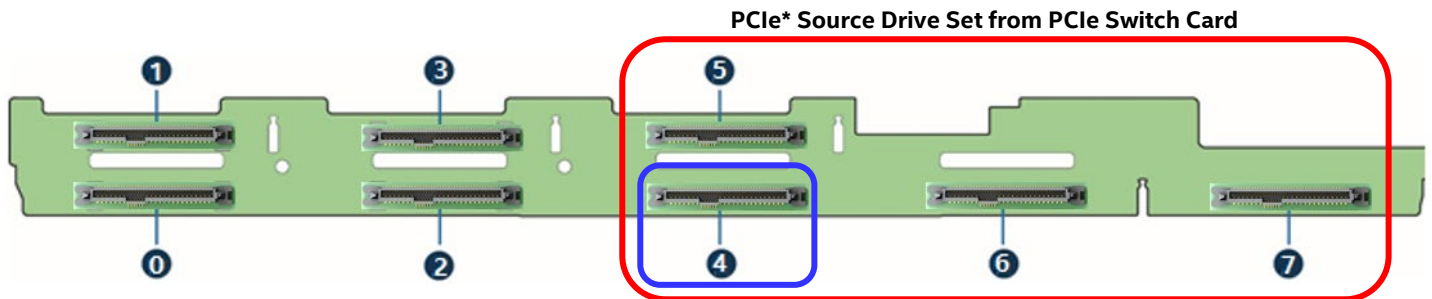


Where 1<sup>st</sup> Drive = drive connectors 0 or 2 and 2<sup>nd</sup> Drive = drive connectors 1 or 3

### 2.8.6.2 4 – Port PCIe\* Switch Card to 8 x 2.5" Combo Backplane

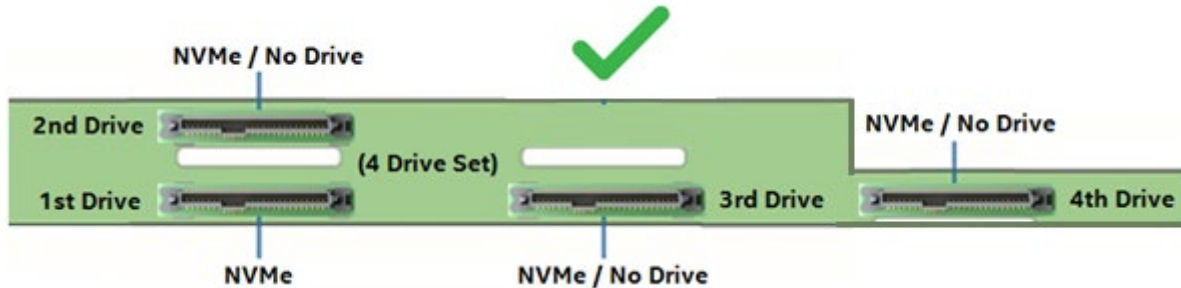
The following information is applicable when PCIe\* signal to the 8x2.5" combo backplane are cabled from a 4-port PCIe\* Switch add-in card.

- NVMe\* drive management sideband signals on the backplane are routed between the following drive connector set: **(4,5,6,7)**
- In order to support NVMe\* drive management within the defined drive set, an NVMe\* drive **MUST** be populated in the first drive connector of the given set (drive connector **4**). Additional NVMe\* drives within the drive set must be populated in sequential order with no gaps between drive connectors.

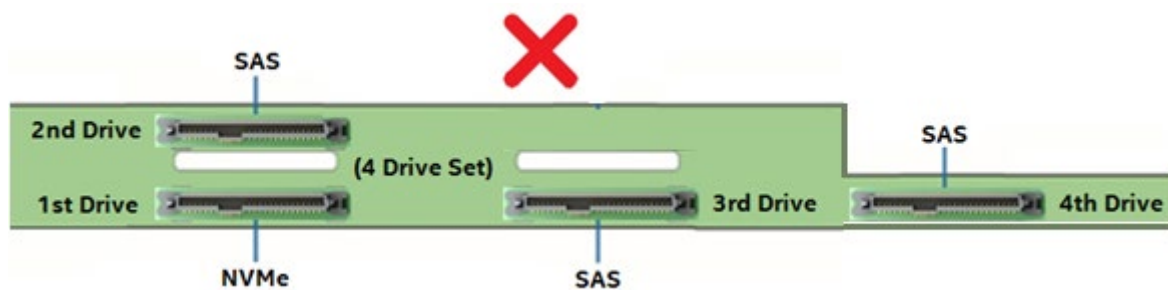


- Combining NVMe\* drives and SAS/SATA drives within the defined drive set is **NOT** supported.

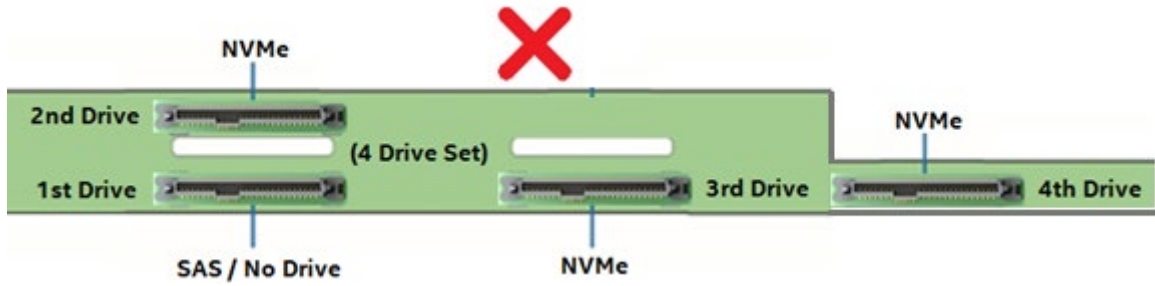
When an Intel® VROC key is installed to the server board, the following illustrations identify supported (✓) and unsupported (✗) drive populations associated with the defined drive set when the PCIe\* source to the backplane is from an add-in PCIe\* Switch card.



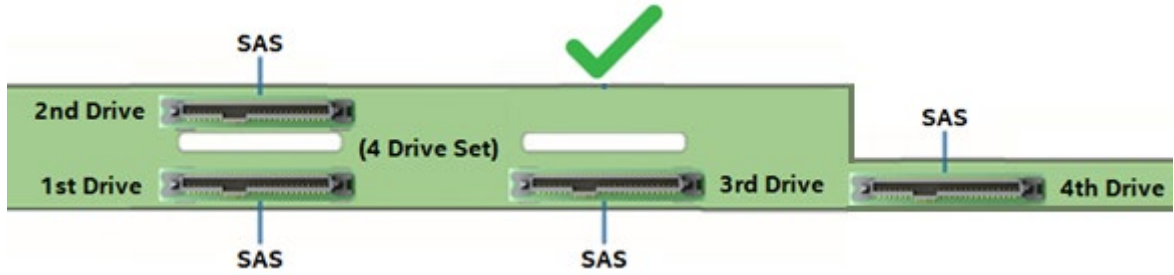
1<sup>st</sup> Drive = NVMe\* + NVMe\* in any sequential drive slot (No gaps)



Mixing NVMe\* and SAS within a common drive set is not supported



NVMe\* not in 1<sup>st</sup> drive and Mixing of NVMe\* and SAS within a common drive set is not supported



SAS Only no NVMe\*

Where 1<sup>st</sup> Drive = drive connectors 4 on the backplane.

## 3. Option and Accessory Kit Integration and Service

---

### Purpose

This chapter provides instructions for the integration of system components within a server system that has the server board and other system components pre-installed. It includes installation instructions for supported system options, and other available accessory option kits.

### Before You Begin

Before working with your server product, observe the safety and ESD precautions found in the Warnings section at the beginning of this manual.

### Tools and Supplies Needed

- Anti-static wrist strap and conductive foam pad (recommended)
- Phillips\* (cross head) screwdriver (#2 bit)

### System Reference

All references to left, right, front, top, and bottom assume the reader is facing the front of the chassis.

### Internal Cable Routing

See Section 2.1.

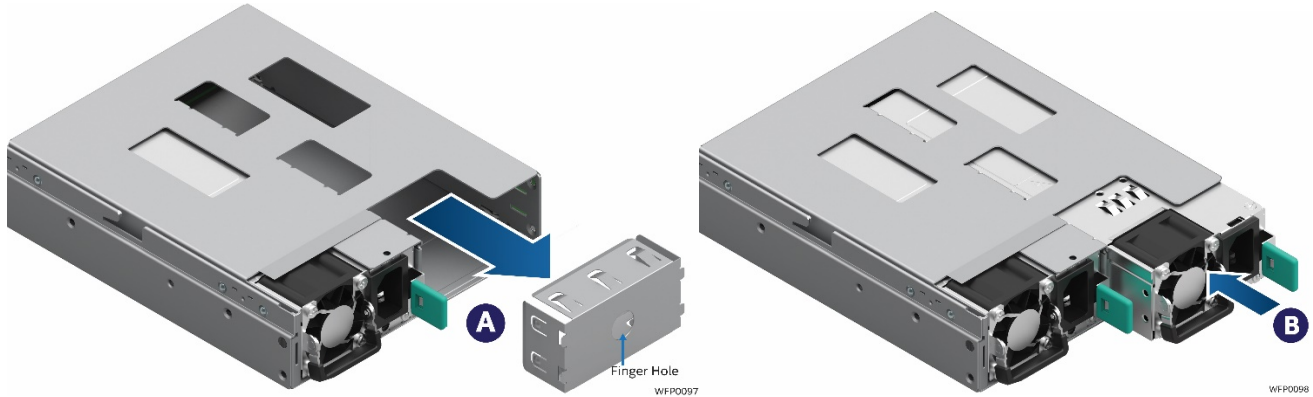
### Instruction Format

Each procedure described in this section will follow an illustration first format. This format will give the reader the option to follow a quicker path to system integration by first seeing an illustration of the intended procedure. If necessary, the reader can then follow the step-by-step instructions that will accompany each procedure.



### 3.1 Power Supply Module – Installation / Removal

#### 3.1.1 2<sup>nd</sup> Power Supply Module Installation



**Figure 65. Power Supply Module Installation**

1. If installed, remove the insert from the chassis power supply bay.
2. Insert the power supply module into the power supply bay (see Letter “B”).
3. Push the power supply module into the bay until it locks into place.

#### 3.1.2 Power Supply Module Removal

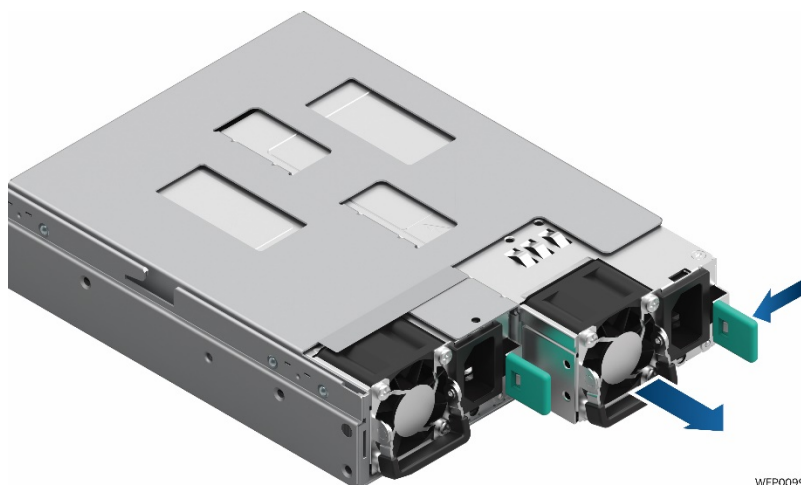
---

**CAUTION:** The power supply is only hot-swappable (system does not have to be powered off) if the system is configured with two power supply modules operating in a 1+1 redundant configuration only.

Systems with a single power supply installed or a system operating in a 2+0 non-redundant power mode, must be powered off before removing the power supply module from the system.

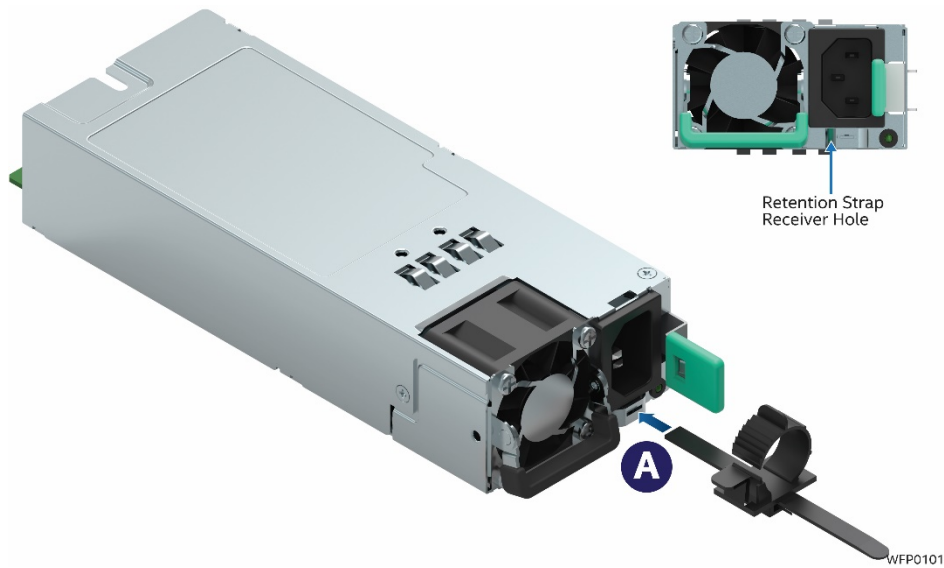
---

1. Detach the power cord from the power supply to be removed.
2. While pushing the green latch in the direction shown, use the handle to pull the power supply module from the system



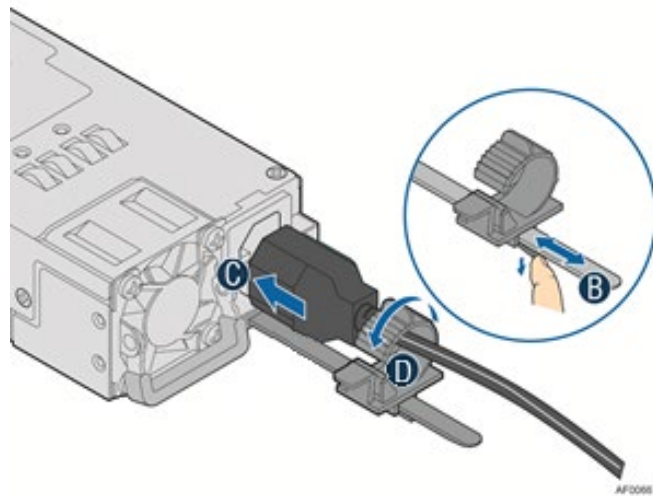
**Figure 66. Power Supply Module Removal**

### 3.1.3 Power Cord Retention Strap Installation



**Figure 67. Power Cord Retention Strap Installation**

1. Locate and remove the power cord retention strap from the system accessory kit.
2. Insert the locking tab end of the Retention Strap into the receiver hole located beneath the power cord receptacle on the back of the power supply module (see Letter “A”).



**Figure 68. Power Cord Plugging**

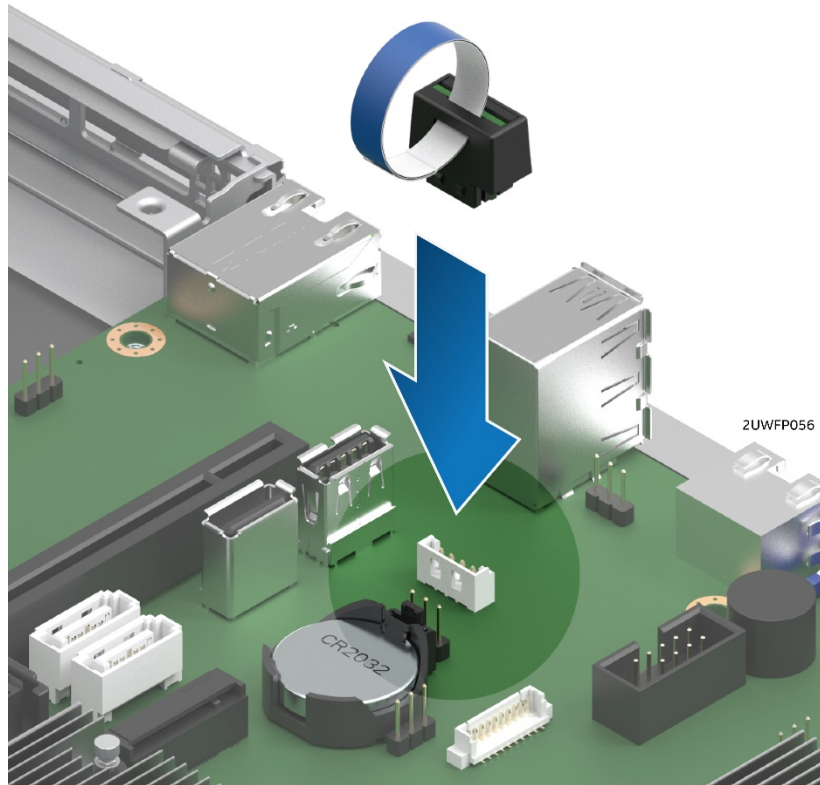
3. While pushing up the locking tab on the bottom of the slider, adjust the slider to the desired position (see Letter “B”).
4. Install the power cord into the power cord receptacle on the back side of the power supply (see Letter “C”).
5. Pull the slider strap over the power cord and lock it securely into place (see Letter “D”).

### 3.1.4 Power Cord Retention Strap Removal

1. Push down on the slider tab to release the slider strap.
2. Pull the slider strap back over the power cord.
3. Remove power cord.

## 3.2 ESRT2 SATA RAID 5 Upgrade Key – Installation / Removal

### 3.2.1 Installing the ESRT2 SATA RAID 5 Upgrade Key



**Figure 69. Installing the SATA RAID 5 Upgrade Key**

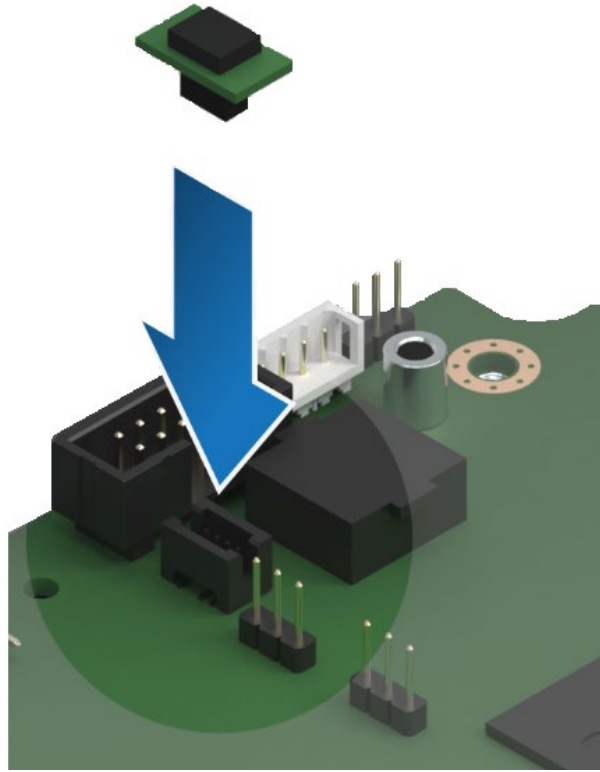
1. Remove the SATA 5 Upgrade Key from its packaging.
2. Locate the white 4-pin key connector above the CR2032 battery on the back edge of the server board.
3. To install the key, place it over the connector and confirm the orientation of the key matches that of the connector.
4. Press the key down onto the connector.

### 3.2.2 Removing the ESRT2 SATA RAID 5 Upgrade Key

1. Power off the system and disconnect the power cable(s).
2. Remove the system cover (see Section 2.2.1).
3. Using the key pull tab, pull the key up until it disengages from the connector.

### 3.3 Intel® Remote Management Module 4 Lite Key – Installation / Removal

#### 3.3.1 Intel® RMM4 Lite Key Installation



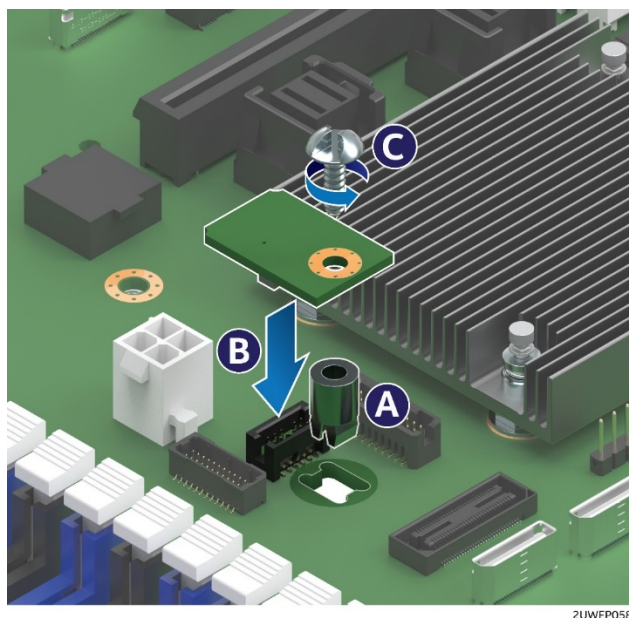
**Figure 70. Installing the Intel® RMM4 Lite**

1. Remove the Intel® RMM4 Lite key from its packaging.
2. Locate the Intel® RMM4 Lite connector on the server board next to the front panel USB 2.0 connector.
3. Place the Intel® RMM4 Lite key over the connector and match the orientation of the key to that of the connector.
4. Press the key down onto the connector.

#### 3.3.2 Intel® RMM4 Lite Key Removal

1. Power off the system and disconnect the power cable(s).
2. Remove the system cover (see Section 2.2.1).
3. Carefully grasp the key and pull it up until it disengages from the connector.

### 3.4 Trusted Platform Module (TPM) Installation



**Figure 71. Trusted Platform Module (TPM) Installation**

1. Locate the TPM module connector on the server just below the PHM.
2. Insert the plastic stand-off into the server board mounting hole (see Letter “A”).
3. Place the TPM module over the connector, match the orientation and press the key down onto the connector (see Letter “B”).
4. Secure the TPM module to the stand-off with the fastener screw (see Letter “C”).

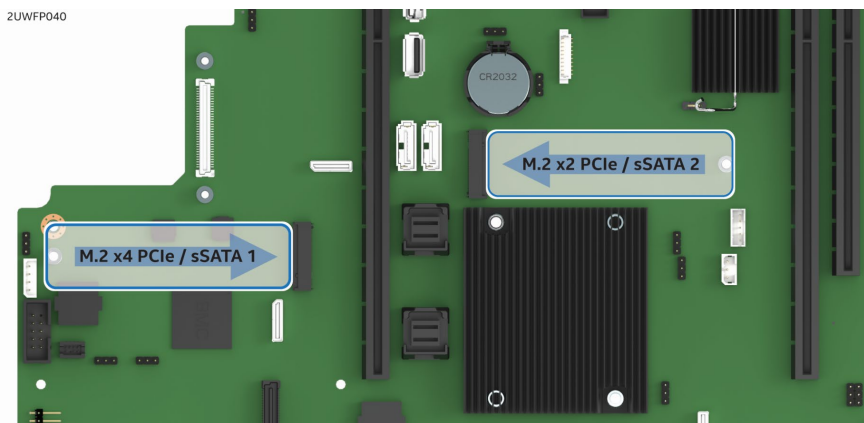
---

**Note:** TPM module comes with two screws in kit, one Philips\* head version and one tamper proof version.

---

### 3.5 M.2 Storage SSD Installation / Removal

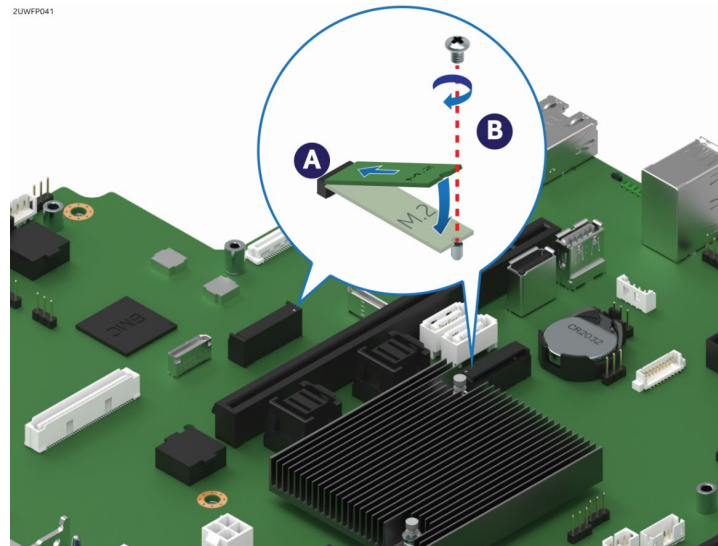
The Intel® Server Board S2600WF product family includes two M.2 SSD connectors labeled “M2\_x4PCIE/sSATA\_1” and “M2\_x2PCIE/sSATA\_2” on the server board as shown below. Each M.2 connector can support PCIe\* or SATA modules that conform to a 2280 (80mm) form factor.



**Figure 72. M.2 Connector Locations**

### 3.5.1 M.2 Storage SSD Installation

There are two onboard M.2 connectors, one located by Riser Slot 1 and the other is located by SATA 4 and 5 connectors.



**Figure 73. Installing M.2 Device**

Screws for M.2 drives are pre-installed on the standoffs.

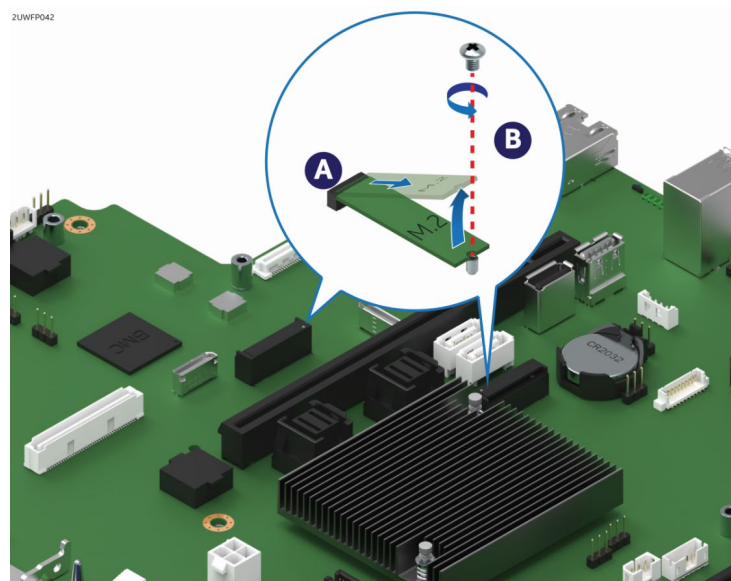
1. Remove the preinstalled screw (see Letter “B”).
2. Insert the drive into the M.2 socket (see Letter “A”).
3. While holding down the M.2 drive, secure it with the previously removed screw (see Letter “B”).

---

**Note:** Not holding down the loose end of the M.2 while installing the screw will cause the board to spring up and make installing the screw difficult.

---

### 3.5.2 M.2 Storage SSD Removal

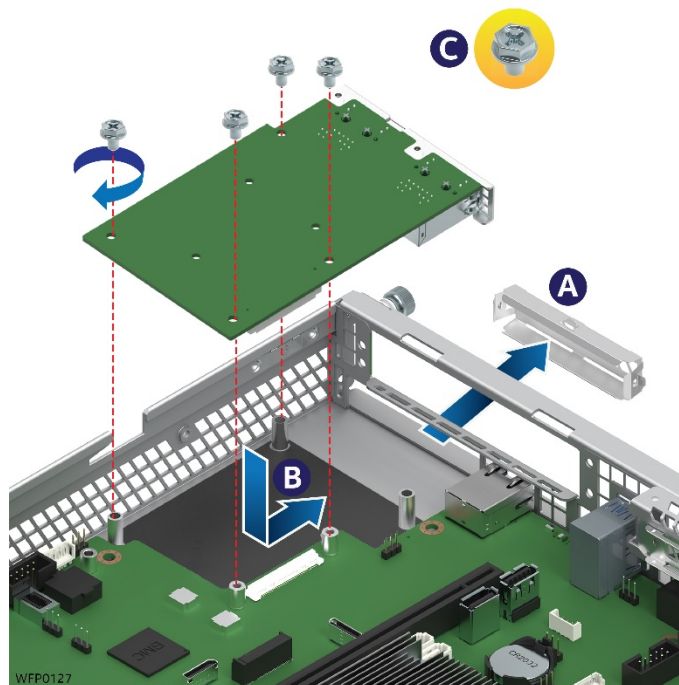


**Figure 74. Removing M.2 Device**

1. Remove the screw to release the M.2 device (See Letter “B”).
2. Remove the M.2 device (see Letter “A”).
3. Re-install screw into M.2 standoff after removing drive.

## 3.6 OCP Expansion Module – Installation / Removal

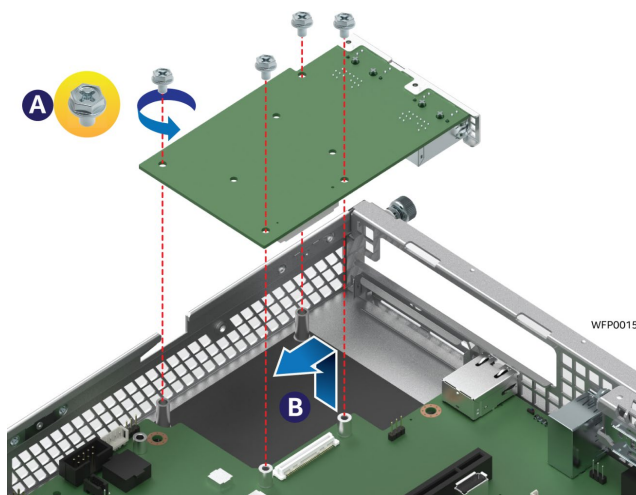
### 3.6.1 OCP Expansion Module Installation



**Figure 75. Installing OCP Expansion Module**

1. Remove the OCP bay filler from the chassis back panel. Squeeze the panels on each side of the filler and push it out from the chassis.
2. Carefully angle and insert the rear connectors of the OCP module into the cut-out on the chassis back panel and position the module over the server board connector. Care should be taken NOT to damage the I/O shield material when placing the OCP module into the back panel cut-out (see Letter “A”).
3. Carefully press down on the module to engage the connectors.
4. Secure the module with four screws as shown (see Letter “B”).

### 3.6.2 OCP Expansion Module Removal



**Figure 76. Removing an OCP Expansion Module**

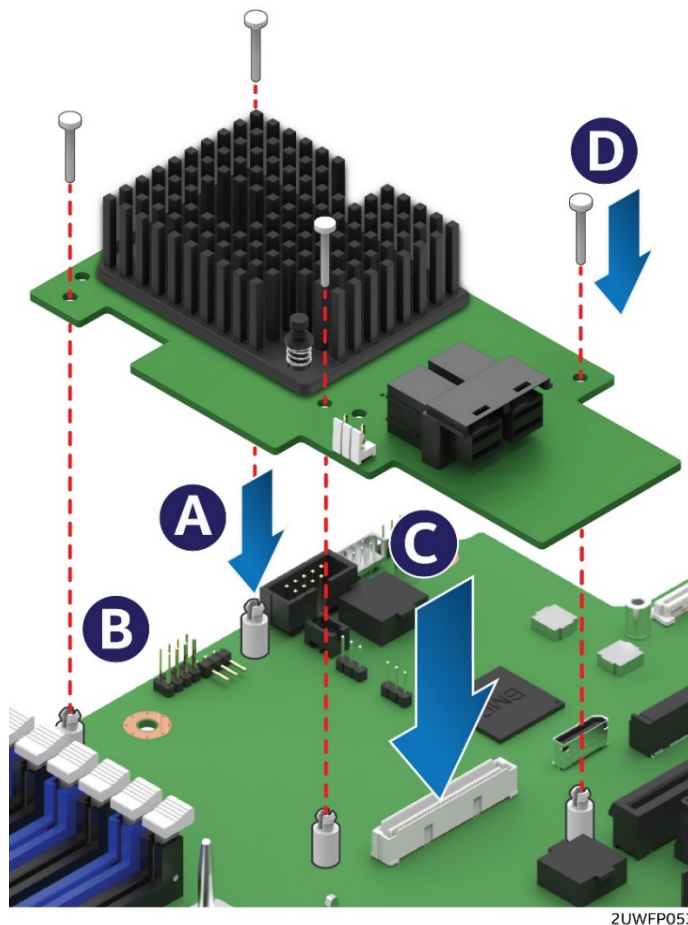
1. Power off the server and detach the power cable(s).
2. Detach all cables from the OCPModule.
3. Remove the system cover – (see Section 2.2.1).

4. Remove the four (4) screws as shown (see Letter “A”).
5. Carefully pull up on the OCP Module until it disengages from the server board (see Letter “B”).
6. If no replacement module is to be installed, re-install the OCP bay filler panel.

**Note:** The filler panel snaps into the back panel from the outside of the chassis.

## 3.7 Intel® SAS RAID Module Installation / Removal

### 3.7.1 Intel® SAS RAID Module Installation



**Figure 77. Intel® SAS RAID Module Installation**

1. Insert the four barrel standoffs into the matching holes in the server board (see Letter “A”).
2. Align the module mounting holes over the four barrel standoffs (see Letter “B”).
3. Press down firmly until the module connector is fully engaged with the matching connector on the server board and the module is firmly seated over each barrel standoff (see Letter “C”).
4. Insert a locking pin into each barrel standoff and connect cables (see Letter “D”).

### 3.7.2 Intel® SAS RAID Module Removal

1. Disconnect cables and remove the four locking pins from each barrel standoff.
2. Grasp the module near the front two barrel standoffs and pull up firmly until the front side of the module is clear of the standoffs.
3. Repeat step 2 to release the other side of the module.

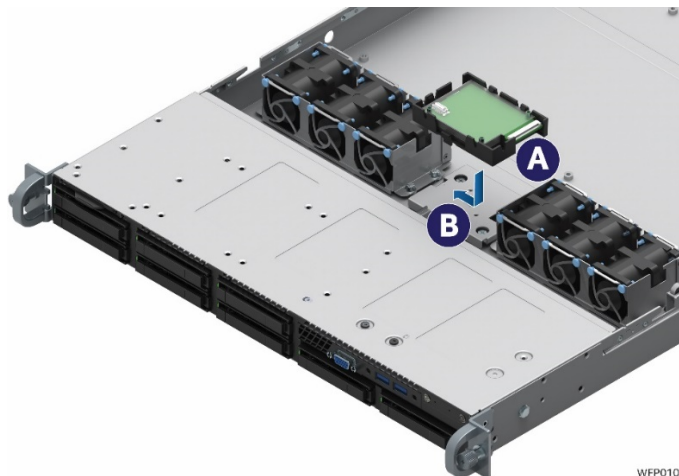
**Note:** Remember to remove the four plastic barrel standoffs when replacing the server board.



### 3.8 Single Intel® RAID Maintenance Free Backup Unit (RMFBU) Installation/Removal

The 1U server system has support for the installation of one or two Raid Maintenance Free Back-up Units (RMFBU). The following sections describe the installation and removal of the single unit accessory option. See Section 3.9 for information related to the dual unit accessory option.

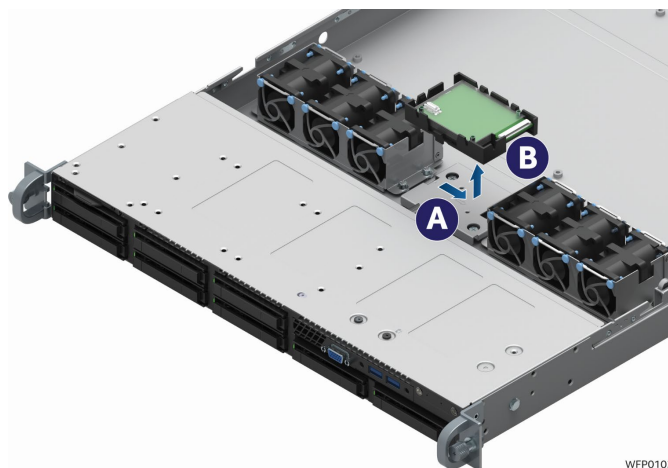
#### 3.8.1 Single Intel® RAID Maintenance Free Backup Unit (RMFBU) Installation



**Figure 78. Single Intel® RAID Maintenance Free Backup Unit (RMFBU) Installation**

1. The RMFBU mounting plate is located in between the two system fan module assemblies. Align the tabs on the bottom side of the RMFBU assembly with the mounting holes in the mounting plate (see Letter “A”).
2. Slide the RMFBU assembly left until the tabs engage with the mounting holes in the mounting plate (see Letter “B”).
3. Using one of the designated cable routing channels route the RMFBU cable to the designated SAS RAID card and attach the cable to the matching connector on the card.

#### 3.8.2 Single Intel® RAID Maintenance Free Backup Unit (RMFBU) Removal



**Figure 79. Intel® RAID Maintenance Free Backup Unit (RMFBU) Removal**

1. Disconnect the cable between the RMFBU and the RAID card.
2. Push down on the release tab located on the side of the RMFBU.
3. Slide the Intel® RAID Maintenance Free Backup Unit to the right to disengage it from the mounting plate (see Letter “A”).
4. Lift the RMFBU up and away from the mounting plate (see Letter “B”).

### 3.9 Dual Intel® RAID Maintenance Free Backup Units (RMFBU) Installation/Removal

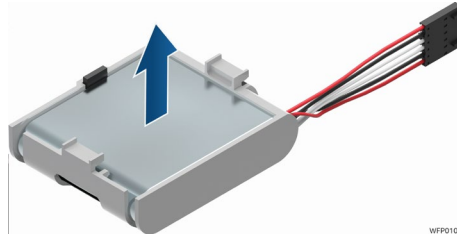
The 1U chassis has support for an optional dual RMFBU mounting assembly. (Intel Accessory Kit - product code **AWTAUXBBUBKT**). The kit can be applied for RMFBU mountings in both 1U and 2U server system. For the 1U chassis, only the plastic dual RMFBU housing and small mounting plate are needed from the kit.

#### 3.9.1 Dual Intel® RAID Maintenance Free Backup Unit (RMFBU) Assembly Installation



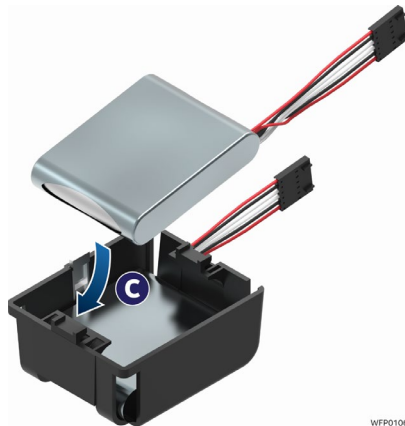
**Figure 80. AWTAUXBBUBKT 1U RMFBU Mounting Plate Installation**

1. Place the new RMFBU mounting plate into the chassis making sure all mounting holes are in alignment.
2. Using the two fastener screws provided, secure the mounting plate to the chassis (see Letter “B”).



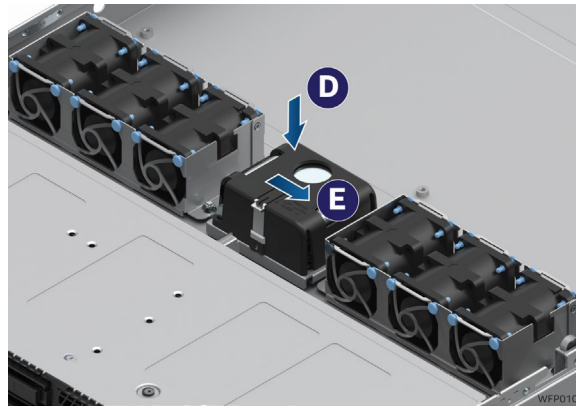
**Figure 81. RMFBU Removal From Standard Housing**

3. Remove the two RMFBUs from their original plastic housings.
4. Locate and remove the dual RMFBU plastic housing from the accessory kit.



**Figure 82. RMFBU Installation Into Dual RMFBU Housing**

5. Install one RMFBU at a time into the dual RMFBU housing. Lower the cable-less end of the RMFBU into the housing (see Letter “C”) and then push the other end down until it sits securely into place.



**Figure 83. Dual RMFBU Assembly Installation**

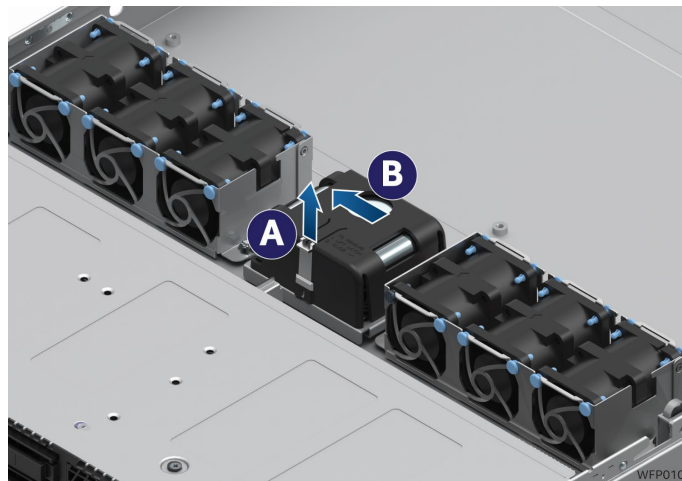
6. Position the Dual RMFBU assembly onto the RMFBU mounting plate located in between the two system fan module assemblies (see Letter “D”) and slide right until the assembly locks into place (see Letter “E”).
7. Using the designated cable routing channels (see Figure 20), route each RMFBU cable to an add-in SAS RAID card.



**Figure 84. Dual RMFBU assembled**

### 3.9.2 Dual Intel® RAID Maintenance Free Backup Unit (RMFBU) Assembly Removal

To disengage the dual RMFBU assembly from the mounting plate:



**Figure 85. Dual RMFBU Assembly Removal**

1. Disconnect the RMFBU cables from the add-in RAID cards.
2. Gently release the tab located on the upper front edge of the RMFBU assembly (see Letter “A”).
3. While holding up the tab (see Letter “A”), slide the assembly to the left until it disengages from the mounting plate (see Letter “B”).
4. Lift the RMFBU up and away from the mounting plate.

### 3.10 Intel® Omni-Path IFT Carrier Accessory Kit Installation

The Intel® Server System R1000WF product family has support for 1 or 2 Intel® Xeon® processor Scalable family SKUs that include an Intel® Omni-Path Host Fabric Interface (HFI) connector. In support of these processor SKUs, one of two available Intel accessory kits is necessary to enable support for the fabric interface.

- **AWF1PFABKITM** – Intel® Omni-Path IFT Carrier Kit – Mezzanine Card
- **AWF1PFABKITP** – Intel® Omni-Path IFT Carrier Kit – PCIe\* Add-in Card

The following sections describe the installation of components included with each kit.

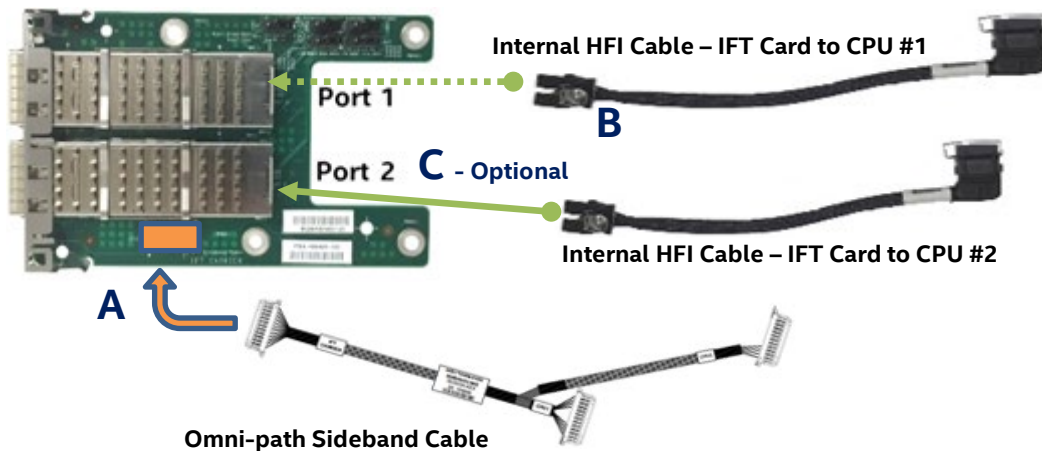
#### 3.10.1 Intel® Omni-path IFT Carrier Kit (iPC AWF1PFABKITM) – Installation

Kit Contents:

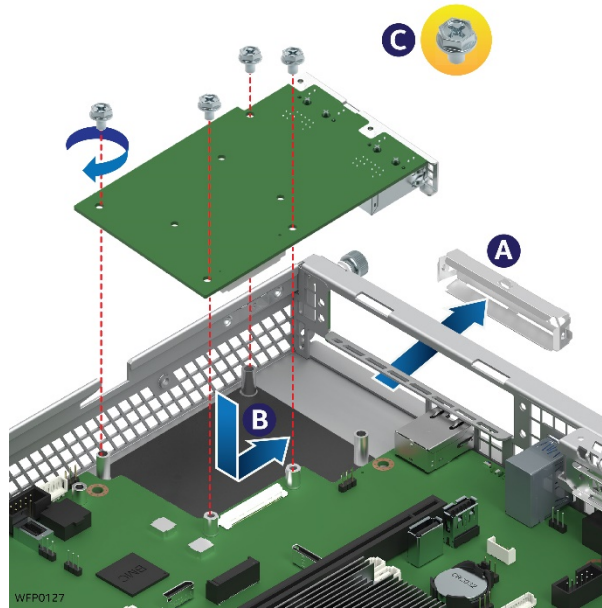
- 1 – Dual port IFT Carrier Mezzanine Card
- 1 – Internal Host Fabric Interface (HFI) Cable (CPU1)
- 1 – Internal Omni-Path Sideband Cable
- 2 – Fabric Processor Carriers

Intel Cable Kit **AXXCBL235IFPL1** required for dual fabric processor configurations.

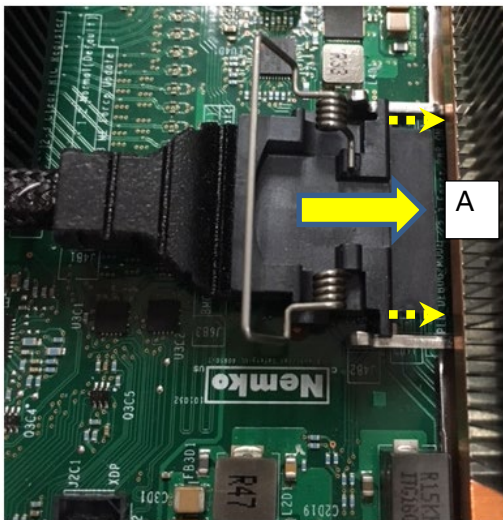
1. Install Fabric processor(s) on to the server board. See Section 2.4 for fabric processor installation instructions.



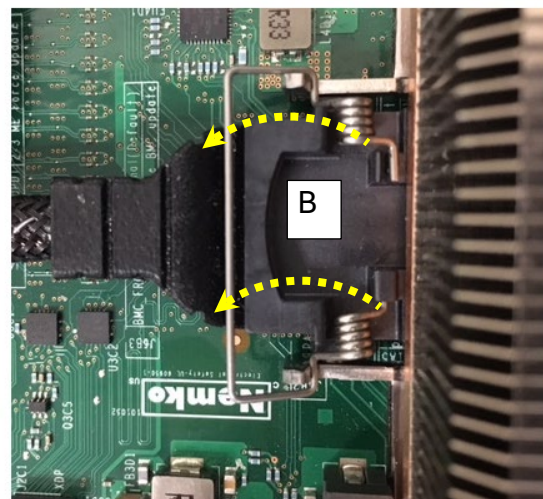
2. Install the internal Omni-path sideband cable to the matching connector on the IFT Carrier mezzanine card (See Letter “A”).
3. Install the internal HFI cable to Port 1 of the IFT Carrier mezzanine card (See Letter “B”).
4. (Optional – For dual Fabric processor configurations) Install the second internal HFI cable to Port 2 of the IFT Carrier mezzanine card (See Letter “C”).



5. Remove the OCP bay filler from the chassis back panel. Squeeze the panels on each side of the filler and push it out of the chassis.
6. Remove the four (4) pre-installed screws from the mounting stand-offs (2 on the server board + 2 on the chassis base).
7. Carefully angle and insert the rear connectors of the IFT Carrier card into the cut-out on the chassis back panel and position the card over the four stand-offs on the server board (see Letter “A”). Care should be taken NOT to damage the I/O shield material when placing the card into the back panel cut-out.
8. Secure the IFT Carrier card with four screws as shown (see Letter “B”).
9. Route the HFI cable attached to Port 1 of the IFT Carrier Card to CPU #1.



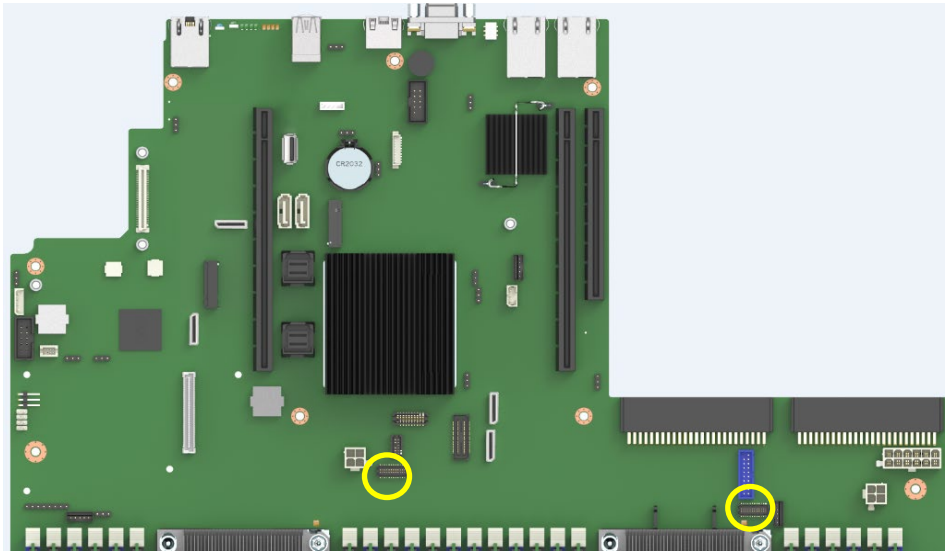
Place and Insert Cable



Lock Cable

**Figure 86. Fabric Processor Cable Installation**

10. Place the HFI cable processor connector within the connector rails on the processor socket and slide processor and cable connectors together (See Letter “A”).
11. Pull the bail wire back until the cable is securely locked in place (See Letter “B”).
12. Repeat Steps 8 through 10 for the second internal HFI cable if present.



Omni-path Sideband Connector

Omni-path Sideband Connector

13. Connect the Omni-path sideband cable from the IFT Carrier card to the two sideband signal connectors on the server board at the locations shown above.

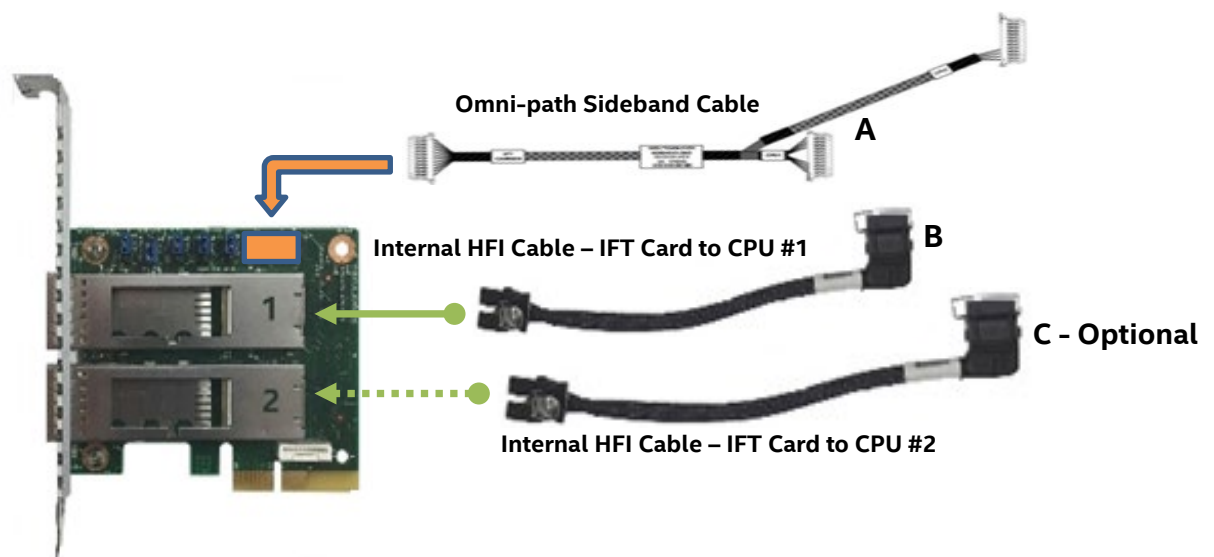
### 3.10.2 Intel® Omni-path IFT Carrier Kit (iPC AWF1PFABKITP) – Installation

Kit Contents:

- 1 – Dual port IFT Carrier PCIe Add-in Card
- 1 – Internal Host Fabric Interface (HFI) Cable (CPU1)
- 1 – Internal Omni-Path Sideband Cable
- 2 – Fabric Processor Carriers

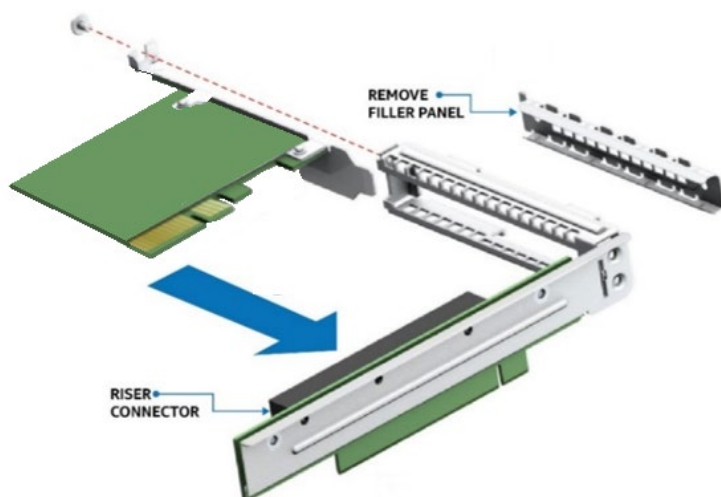
Intel Cable Kit **AXXCBL370IFPS1** required for dual fabric processor configurations.

1. Install Fabric processor(s) on to the server board. See Section 2.4 for fabric processor installation instructions.

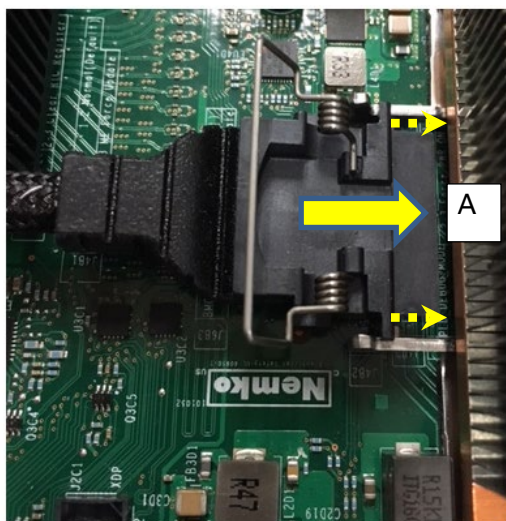


2. Install the internal Omni-path sideband cable to the matching connector on the IFT Carrier mezzanine card (See Letter “A”).

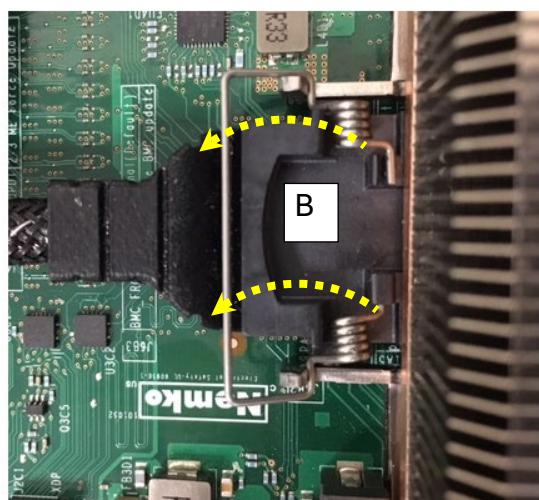
3. Install the internal HFI cable to Port 1 of the IFT Carrier mezzanine card (See Letter “B”).
4. (Optional – For dual Fabric processor configurations) Install the second internal HFI cable to Port 2 of the IFT Carrier mezzanine card (See Letter “C”).



5. Remove the Riser #2 bracket assembly from the system and install the IFT Carrier card to the add-in card slot.
6. Route the HFI cable attached to Port 1 of the IFT Carrier Card to CPU #1.



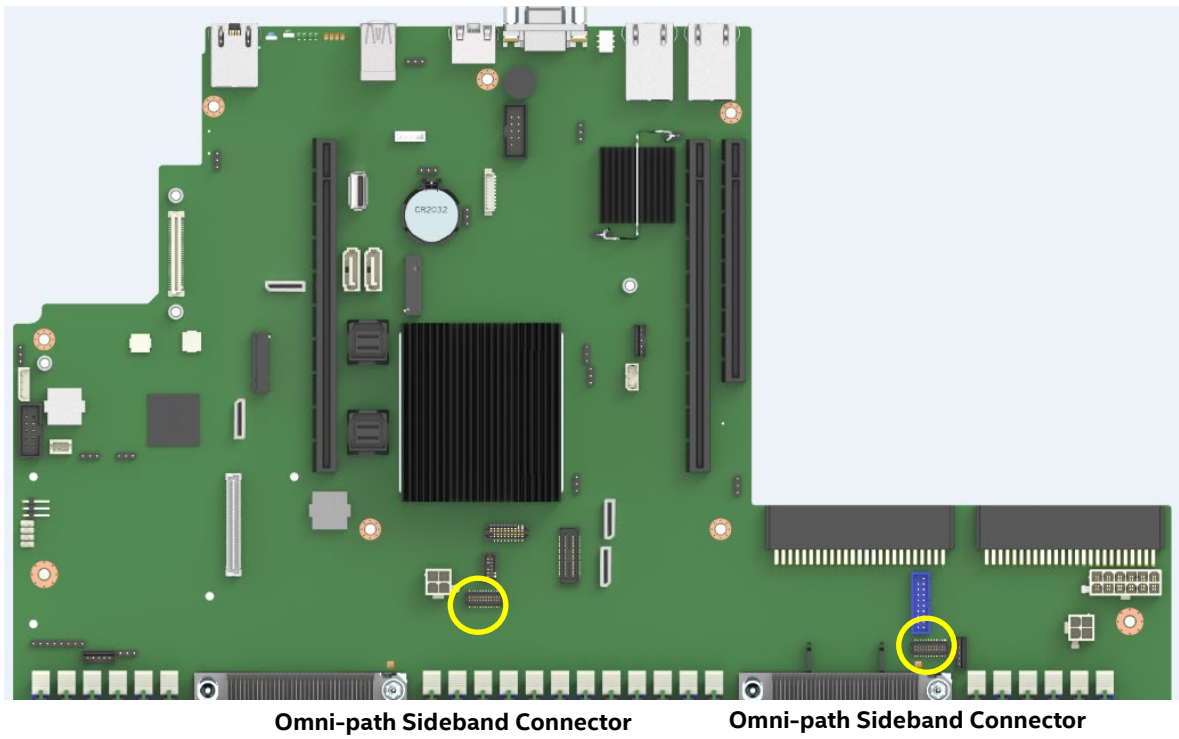
Place and Insert Cable



Lock  
Cable

**Figure 87. Fabric Cable Processor Connector Placement**

7. Place the HFI cable processor connector within the connector rails on the processor socket and slide processor and cable connectors together (See Letter “A”).
8. Pull the bail wire back until the cable is securely locked in place (See Letter “B”).
9. Repeat Steps 8 through 10 for the second internal HFI cable if present.



10. Connect the Omni-path sideband cable from the IFT Carrier card to the two sideband signal connectors on the server board at the locations shown above.



## 4. System Software Updates and Configuration

---

### 4.1 Updating the System Software Stack

The system includes a software stack to operate, including a BIOS, BMC firmware, ME firmware, and FRU & SDR data. A default software stack is loaded during the system manufacturing process. However, it may not be the latest available. For best operation and system reliability, it is highly recommended to update the system software stack to the latest available.

The latest system software stack can be downloaded from Intel at the following Intel web site:

<https://www.intel.com/content/www/us/en/support/products/89017/server-products/server-systems/intel-server-system-r1000wf-family.html>

At a minimum, after the initial configuration, the system's FRU and SDR data MUST be updated to ensure that the embedded platform management sub-system is configured properly. The system's FRU and SDR data is updated by running the FRUSDR utility. Properly loaded FRU and SDR data allows platform management to monitor the appropriate system sensors, which are used to determine proper system cooling, best performance, and accurate error reporting. The FRUSDR utility is included in the platform's System Update Package (SUP) which can be downloaded from the Intel web site referenced above. The SUP will include full system update instructions.

### 4.2 Using the BIOS Setup Utility

This section describes how to access and navigate the embedded <F2> BIOS Setup utility. This utility can be used to view and configure system settings that determine how the server operates.

#### 4.2.1 Entering BIOS Setup

To enter the BIOS Setup using a keyboard (or emulated keyboard), press the <F2> function key during boot time when the OEM or Intel Logo Screen or the POST Diagnostic Screen is displayed.

---

**Note:** At initial system power-on, a USB Keyboard will not be functional until the USB Controller has been initialized during the power on self test (POST) process. When the USB controller is initialized, the system will beep once. Only after that time the key strokes from a USB Keyboard will be recognized allowing for access into the <F2> BIOS Setup utility.

---

The following message will be displayed on the Diagnostic Screen or under the Quiet Boot Logo Screen:

**Press <F2> to enter setup, <F6> Boot Menu, <F12> Network Boot**

After pressing the <F2> key, the system will eventually load the BIOS Setup Utility and display the BIOS Setup Main Menu screen.

---

**Note:** Should serious system errors occur during the POST process, the regular system boot will stop and the system will load the BIOS Setup Utility and display the Error Manager Screen. The Error Manager Screen will list and provide information about the specific boot errors detected

---

#### 4.2.2 No Access to the BIOS Setup Utility

If the BIOS Setup Utility is not accessible by hitting the <F2> key or other described access methods, it may be necessary to restore the BIOS default settings. For information relating to restoring BIOS defaults, see Section 6.2 BIOS Default Jumper Block.

### 4.2.3 Navigating the BIOS Setup Utility

The BIOS Setup Utility consists of several menu screens, each holding either informational fields and/or configurable system setup options.

The bottom right portion of each menu screen provides a list of commands that are used to navigate through the Setup utility. These commands are displayed at all times.

If no Administrator or User password is used, all available settings are configurable and can be set by anyone with access to BIOS Setup.

System settings that are not configurable, because of security settings or configuration limits, will be grayed out and are not accessible.

**Table 3. BIOS Setup: Keyboard Command Bar**

Key	Option	Description
<Enter>	Execute Command	The <Enter> key is used to activate submenus when the selected feature is a submenu, or to display a pick list if a selected option has a value field, or to select a subfield for multi-valued features like time and date. If a pick list is displayed, the <Enter> key selects the currently highlighted item, undoes the pick list, and returns the focus to the parent menu.
<Esc>	Exit	The <Esc> key provides a mechanism for backing out of any field. When the <Esc> key is pressed while editing any field or selecting features of a menu, the parent menu is re-entered.  When the <Esc> key is pressed in any submenu, the parent menu is re-entered. When the <Esc> key is pressed in any major menu, the exit confirmation window is displayed and the user is asked whether changes can be discarded. If “No” is selected and the <Enter> key is pressed, or if the <Esc> key is pressed, the user is returned to where they were before <Esc> was pressed, without affecting any existing settings. If “Yes” is selected and the <Enter> key is pressed, the setup is exited and the BIOS returns to the main System Options Menu screen.
↑	Select Item	The up arrow is used to select the previous value in a pick list, or the previous option in a menu item’s option list. The selected item must then be activated by pressing the <Enter> key.
↓	Select Item	The down arrow is used to select the next value in a menu item’s option list, or a value field’s pick list. The selected item must then be activated by pressing the <Enter> key.
← →	Select Menu	The left and right arrow keys are used to move between the major menu pages. The keys have no effect if a sub-menu or pick list is displayed.
<Tab>	Select Field	The <Tab> key is used to move between fields. For example, <Tab> can be used to move from hours to minutes in the time item in the main menu.
-	Change Value	The minus key on the keypad is used to change the value of the current item to the previous value. This key scrolls through the values in the associated pick list without displaying the full list.
+	Change Value	The plus key on the keypad is used to change the value of the current menu item to the next value. This key scrolls through the values in the associated pick list without displaying the full list. On 106-key Japanese keyboards, the plus key has a different scan code than the plus key on the other keyboards, but will have the same effect.

Key	Option	Description
<b>&lt;F9&gt;</b>	Setup Defaults	<p>Pressing the &lt;F9&gt; key causes the following to display:</p> <div style="border: 1px solid black; padding: 5px; margin: 10px 0;"> <p>Load Optimized Defaults? Yes No</p> </div> <p>If "Yes" is highlighted and &lt;Enter&gt; is pressed, all Setup fields are set to their default values. If "No" is highlighted and &lt;Enter&gt; is pressed, or if the &lt;Esc&gt; key is pressed, the user is returned to where they were before &lt;F9&gt; was pressed without affecting any existing field values.</p>
<b>&lt;F10&gt;</b>	Save and Exit	<p>Pressing the &lt;F10&gt; key causes the following message to display:</p> <div style="border: 1px solid black; padding: 5px; margin: 10px 0;"> <p>Save configuration and reset? Yes No</p> </div> <p>If "Yes" is highlighted and &lt;Enter&gt; is pressed, all changes are saved and the Setup is exited. If "No" is highlighted and &lt;Enter&gt; is pressed, or the &lt;Esc&gt; key is pressed, the user is returned to where they were before &lt;F10&gt; was pressed without affecting any existing values.</p>

## 5. System Packaging Assembly

---

The original Intel packaging, in which the server system is delivered, is designed to provide protection to a fully configured system and was tested to meet ISTA (International Safe Transit Association) Test Procedure 3A (2008). The packaging was also designed to be re-used for shipment after system integration has been completed.

The original packaging includes two layers of boxes – an inner box and the outer shipping box, and various protective inner packaging components. The boxes and packaging components are designed to function together as a protective packaging system. When reused, all of the original packaging material must be used, including both boxes and each inner packaging component. In addition, all inner packaging components **MUST** be reinstalled in the proper location to ensure adequate protection of the system for subsequent shipment.

---

**Note:** The design of the inner packaging components does not prevent improper placement within the packaging assembly. There is only one correct packaging assembly that will allow the package to meet the ISTA (International Safe Transit Association) Test Procedure 3A (2008) limits.

Failure to follow the specified packaging assembly instructions may result in damage to the system during shipment.

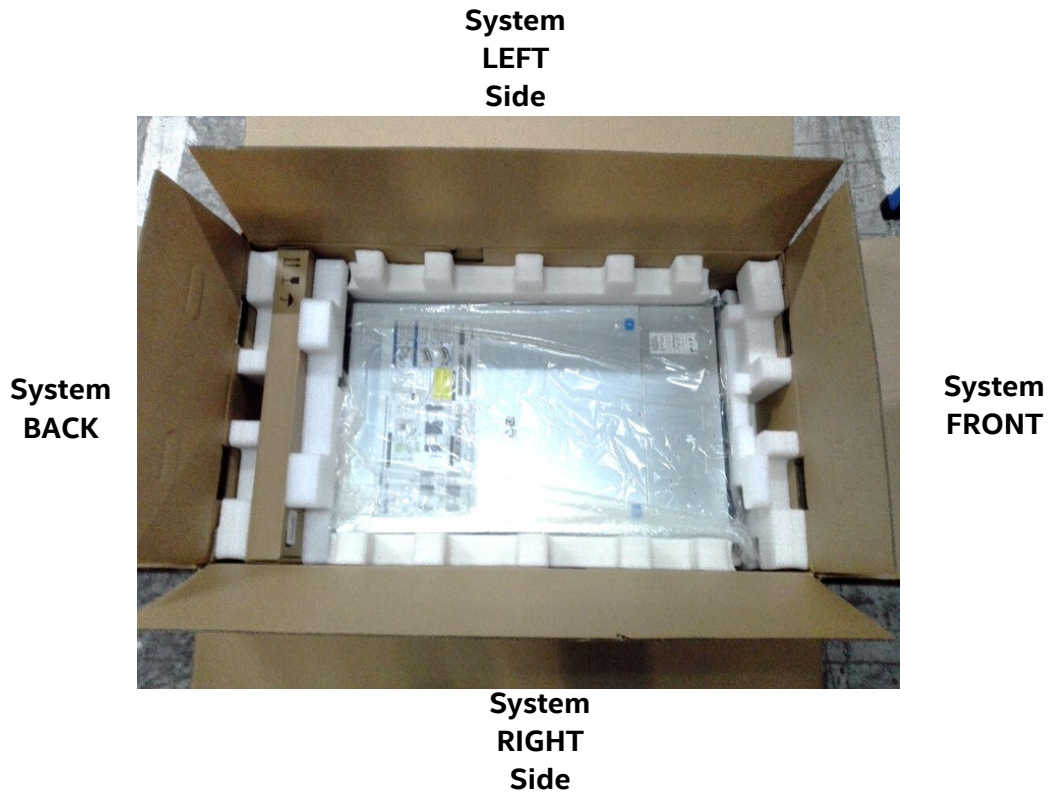
---

### 5.1 Accessory Kit

All loose components planned to ship with the system should be placed inside the Accessory Kit box (iPN H52299-001). Piece parts shown in the following photograph are for reference purposes only. Actual Accessory Kit contents may vary.

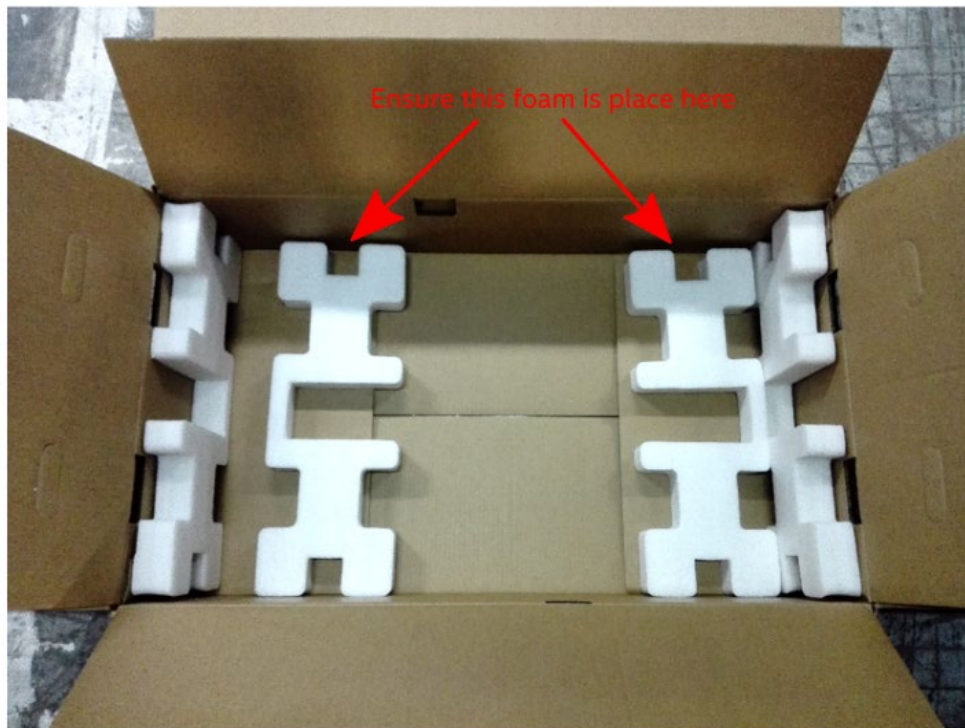


## System Packaging Assembly Instructions



**Figure 88. Package Assembly Reference Diagram**

1. Place four foam inserts into the inner box as shown noting foam insert orientation.
2. Place the Accessory Kit box between the end foam insert and the end wall of the inner box as shown.



3. Place the two side wall foam inserts.



4. Place three corrugated double-wall cardboard pads on top of the two bottom foam inserts as shown.



5. Carefully place the system into the shipping bag and tape the bag shut.
6. Carefully lower the system into the inner shipping box as shown.



7. Place the accessory box next to the foam insert located in the back of the box.
8. Place foam insert in front of the accessory box.



9. At the front of the system, between the front foam insert and system front panel, place the foam insert labeled J36266-001.



10. Place four corrugated double wall cardboard panels on top of the system.





11. Place the two remaining foam inserts on top of the cardboard panels in the positions shown.



12. Fold the top flaps of the inner box closed, end flaps first, followed by side flaps.

---

**Note:** By design, the two side flaps will not meet. Do not tape side flaps shut.

---



13. Fold the top flaps of the outer box, end flaps first, followed by the side flaps.

14. Tape the outer box using an H-pattern, across the center first, followed by both ends.



## 6. System Service - System Features Overview

The intent of this chapter is to provide service personnel a reference to identify and locate the features associated with the Intel® Server System R1000WF product family.

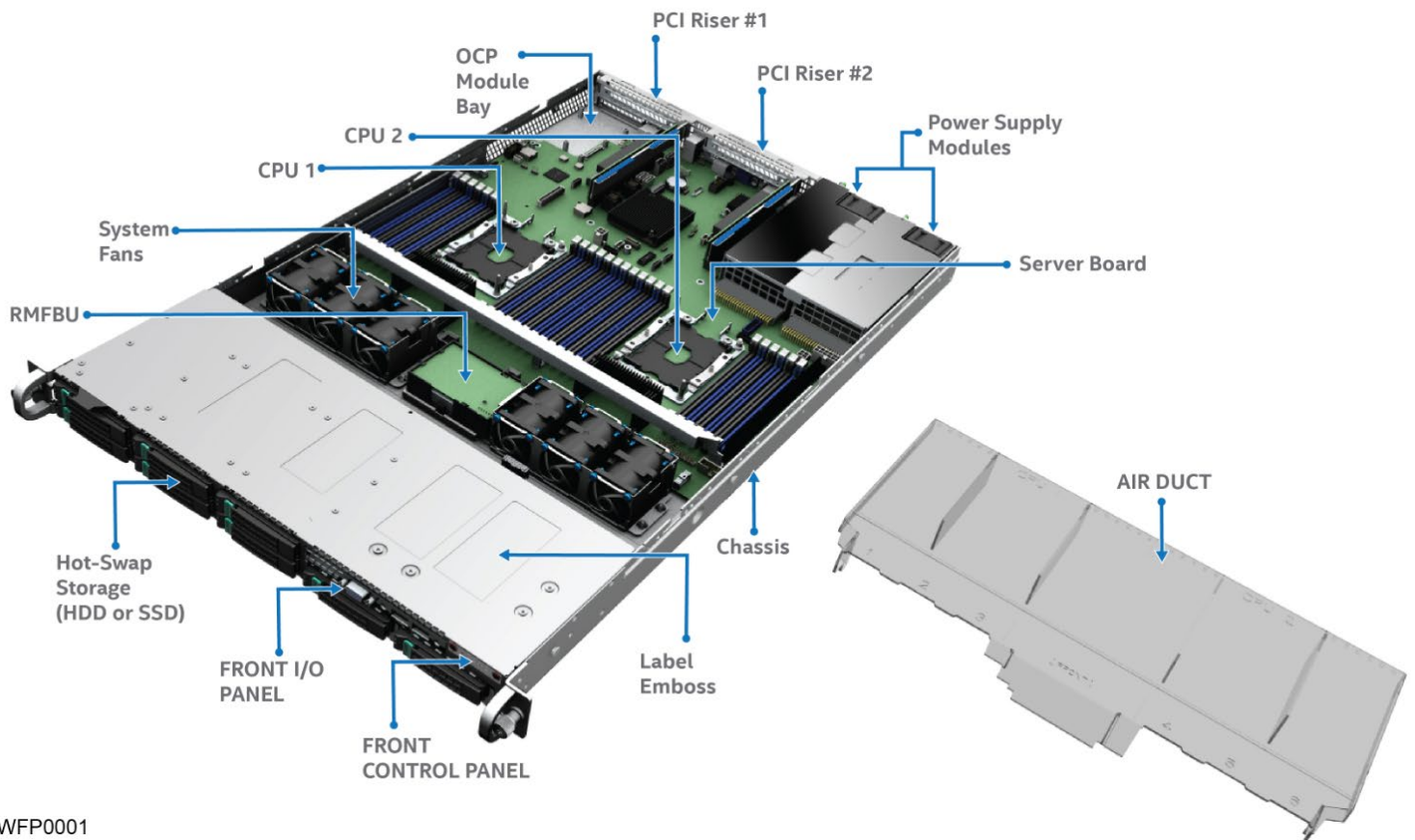
Additional information for this product family can be obtained from the following Intel documents, which can be downloaded from the following Intel web site:

<http://www.intel.com/support>

- Intel® Server System R1000WF Technical Product Specification
- Intel® Server Board S2600WF Technical Product Specification

### 6.1 System Feature Reference Diagrams

This section provides a high level overview of the Intel® Server System R1000WF product family. It provides illustrations and diagrams showing the location of important components, features, and connections found throughout the server system.



WFP0001

Figure 89. Intel® Server System R1000WF Features Overview

### 6.1.1 Front Drive Bay Options



Figure 90. 3.5" Drive Bay – 4 Drive Configuration – Intel® Server System R1304WFxxxx



Figure 91. 2.5" Drive Bay – 8 Drive Configuration – Intel® Server System R1208WFxxxx

### 6.1.2 Control Panel Features

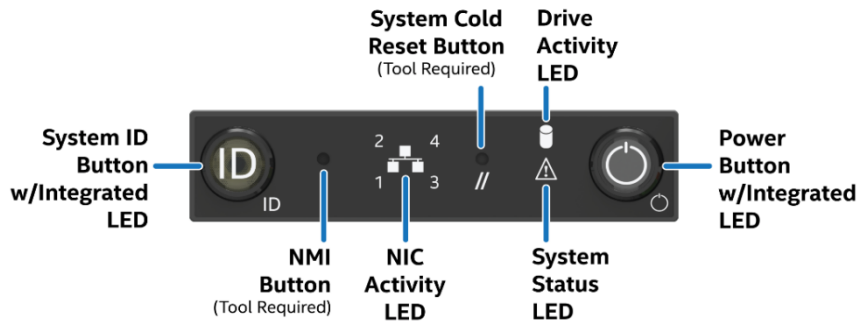


Figure 92. Control Panel Features

### 6.1.3 Front I/O Features

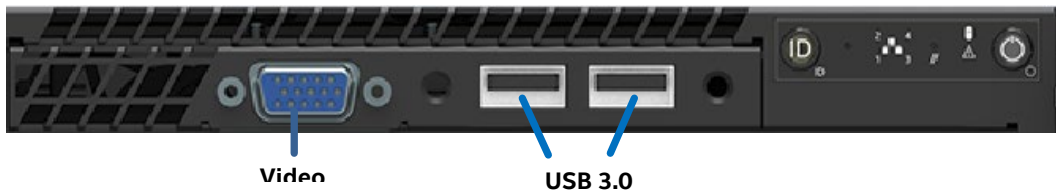


Figure 93. Front I/O Panel Features

### 6.1.4 Back Panel Features

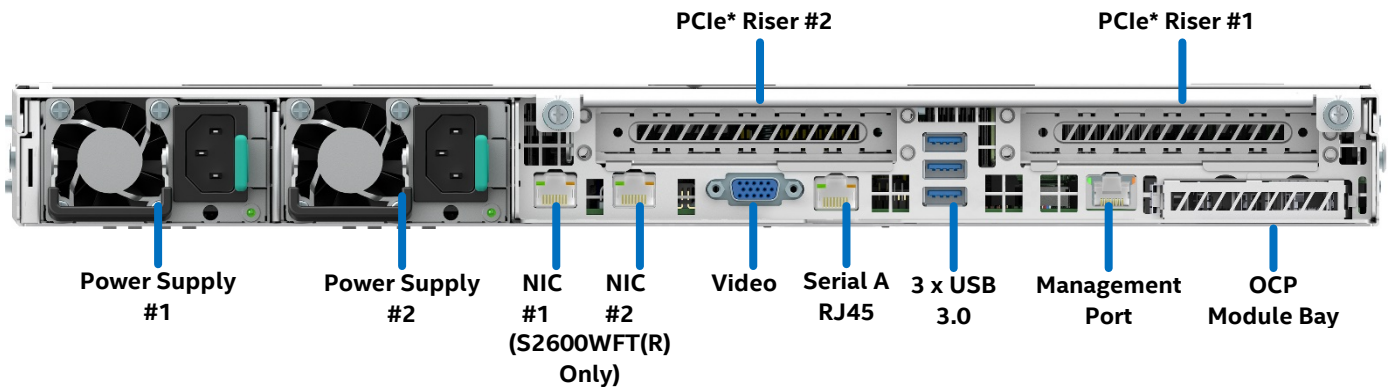
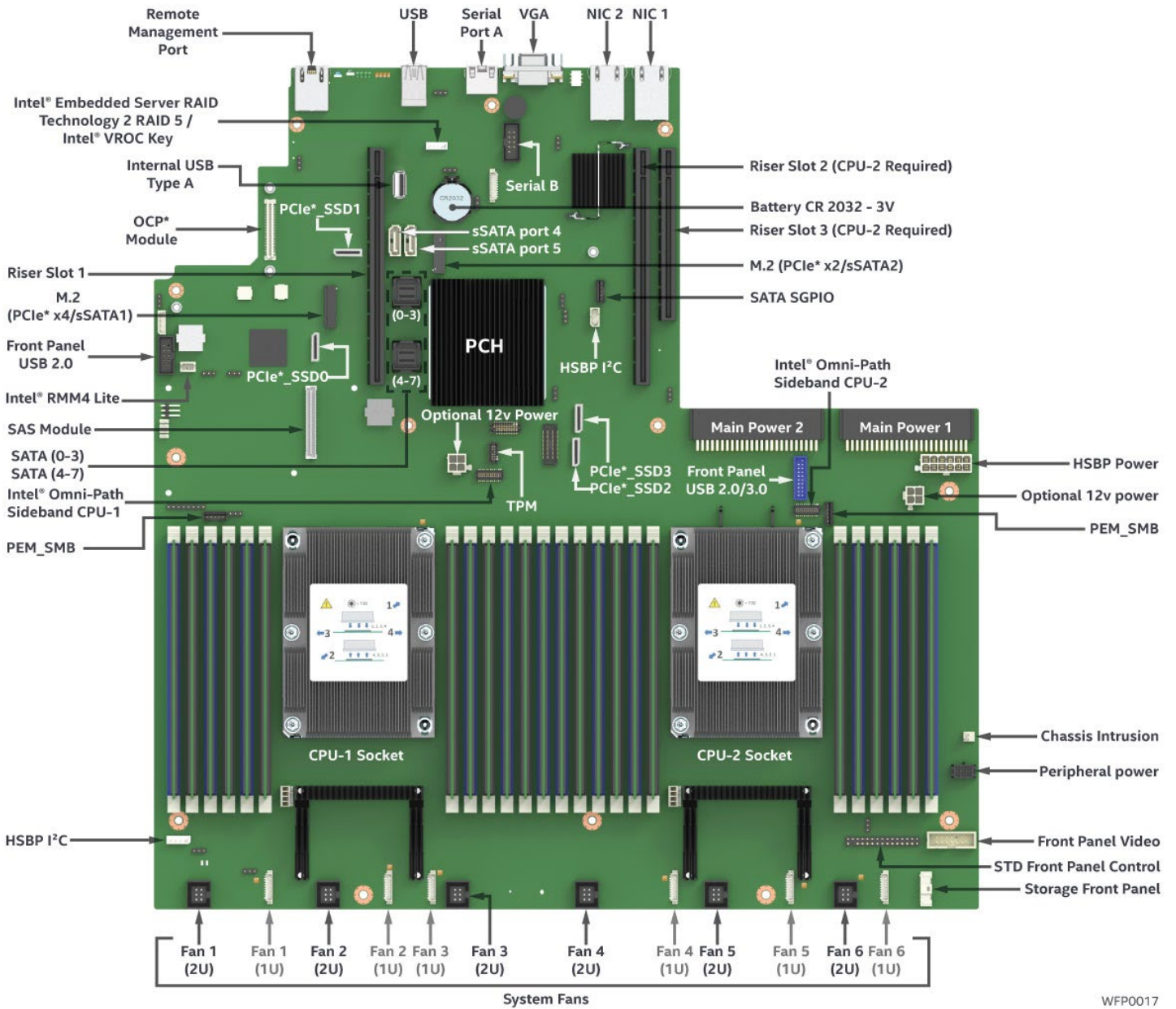


Figure 94. Back Panel Features

### 6.1.5 Server Board Features



WFP0017

Figure 95. Server Board Feature Identification

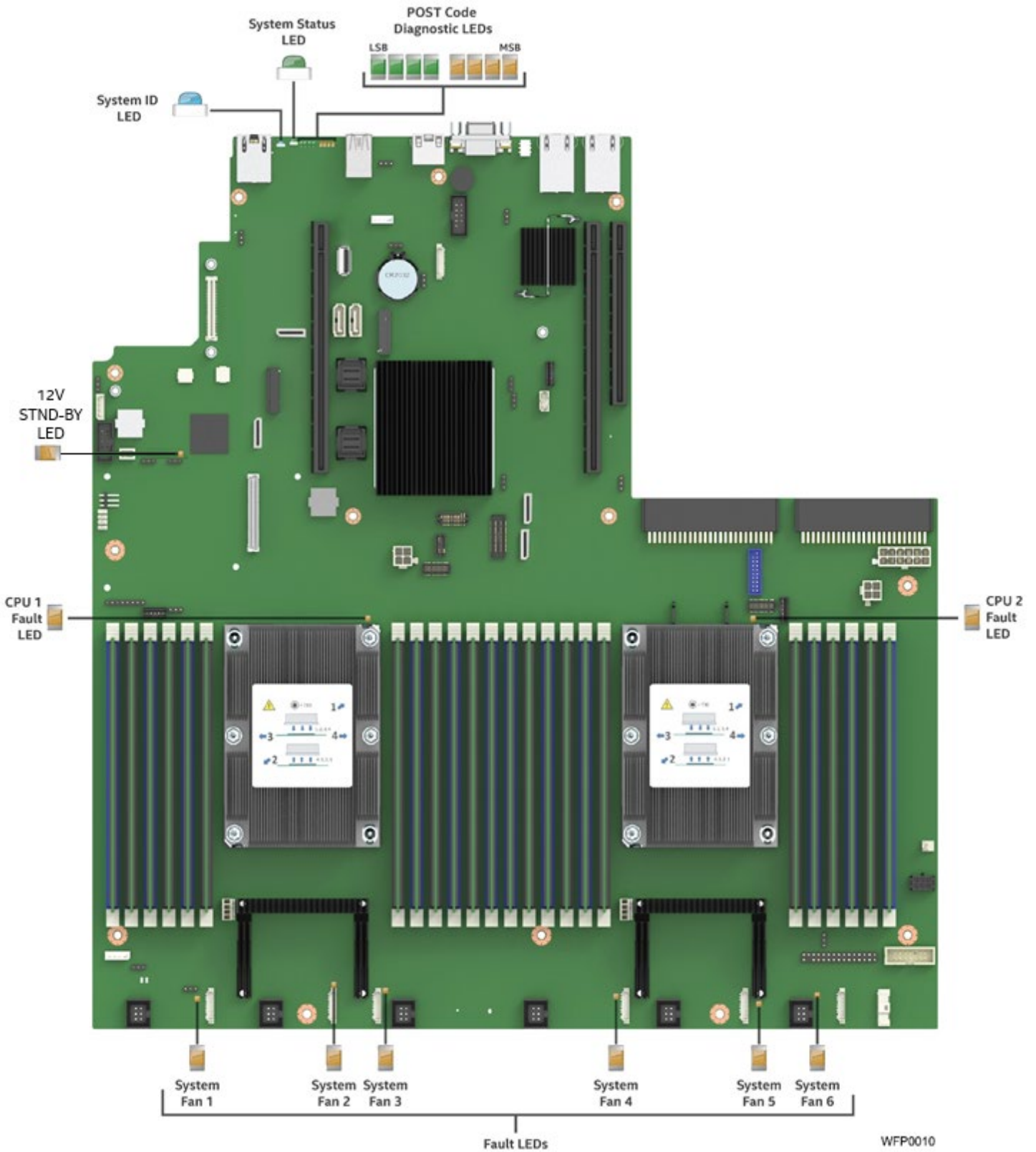


Figure 96. Intel® Light-Guided Diagnostic LEDs - Server Board

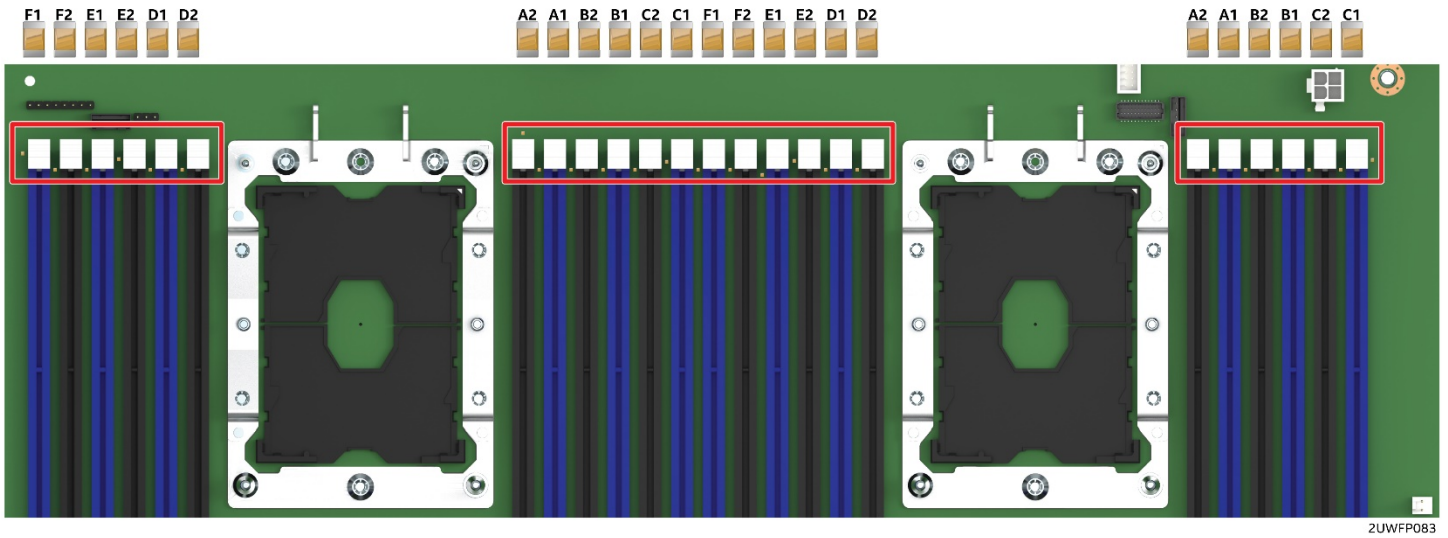


Figure 97. DIMM Fault LEDs

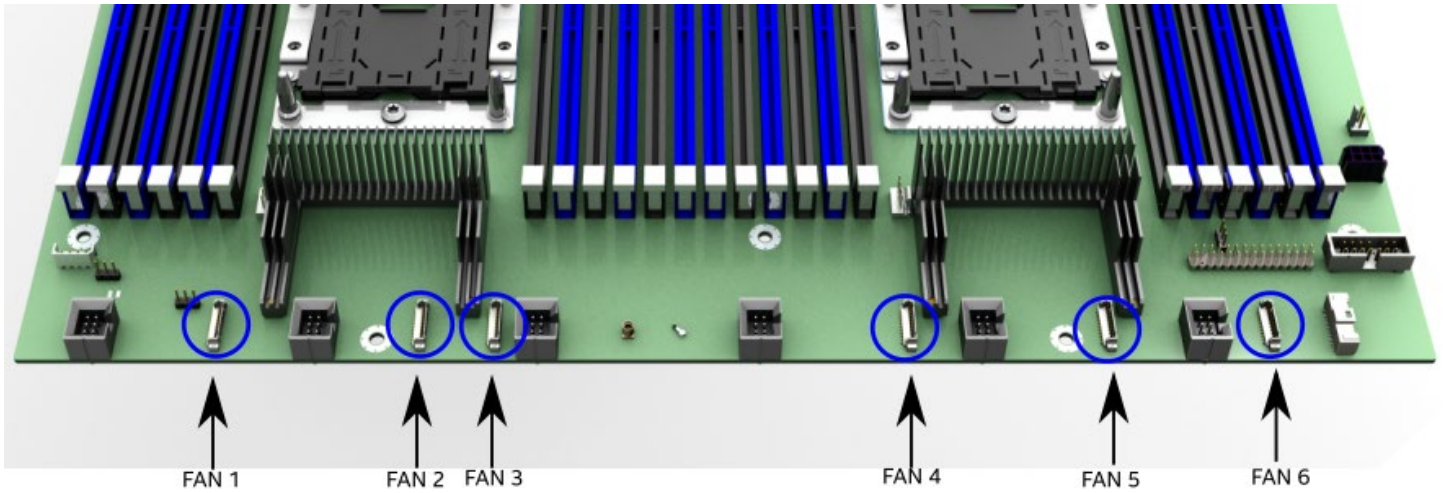
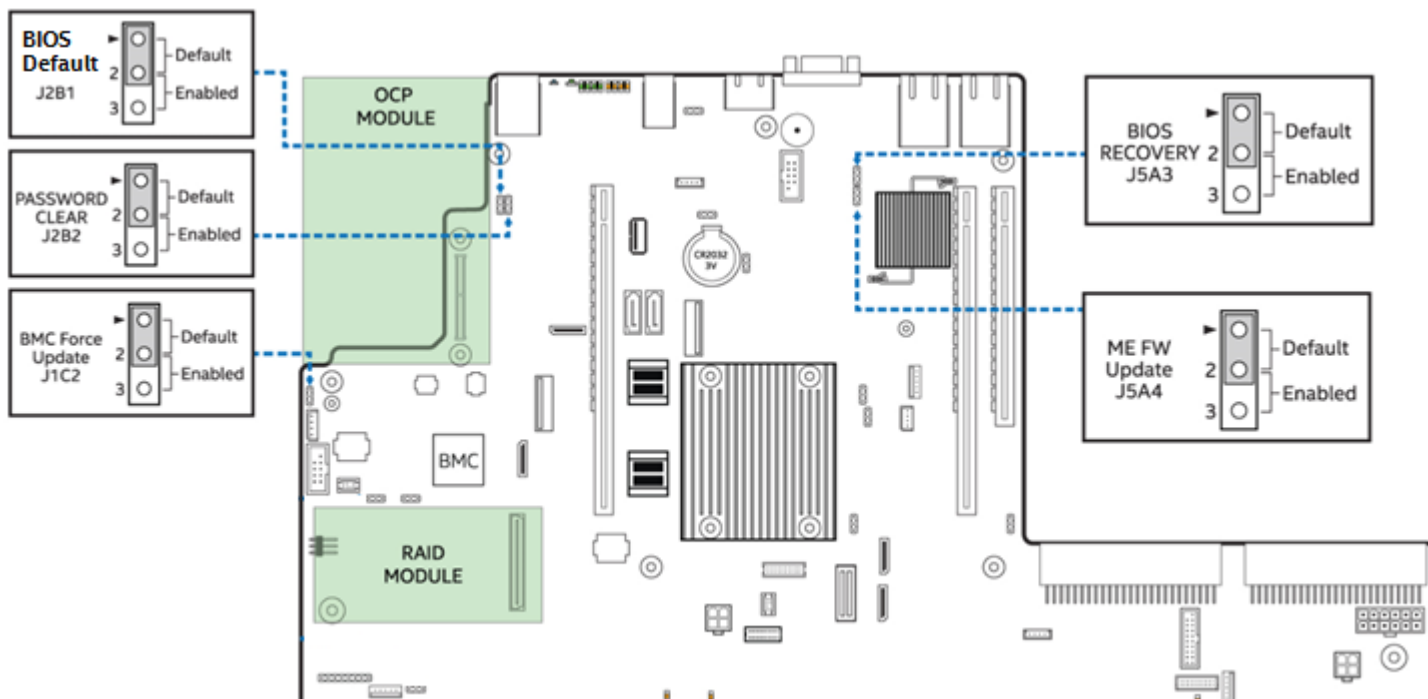


Figure 98. System Fan Connections

## 6.2 System Configuration and Recovery Jumpers



**Figure 99. System Configuration and Recovery Jumpers**

The following sections describe how each jumper block is used.

### 6.2.1 BIOS Default Jumper Block

This jumper resets BIOS options, configured using the <F2> BIOS Setup Utility, back to their original default factory settings.

---

**Note:** This jumper does not reset Administrator or User passwords. In order to reset passwords, the Password Clear jumper must be used

---

1. Power down the server and unplug the power cord(s)
2. Remove the system top cover and move the “BIOS DFLT” jumper from pins 1–2 (default) to pins 2–3 (Set BIOS Defaults)
3. Wait 5 seconds then move the jumper back to pins 1–2
4. Re-install the system top cover
5. Re-Install system power cords

---

**Note:** The system will automatically power on after AC is applied to the system.

---

6. During POST, access the <F2> BIOS Setup utility to configure and save desired BIOS options

---

**Note:** After resetting BIOS options using the BIOS Default jumper, the Error Manager Screen in the <F2> BIOS Setup Utility will display two errors:

- 0012 System RTC date/time not set
- 5220 BIOS Settings reset to default settings

---

**Note:** The system time and date may need to be reset.

---



### 6.2.2 Password Clear Jumper Block

This jumper causes both the User password and the Administrator password to be cleared if they were set. The operator should be aware that this creates a security gap until passwords have been installed again through the <F2> BIOS Setup utility. This is the only method by which the Administrator and User passwords can be cleared unconditionally. Other than this jumper, passwords can only be set or cleared by changing them explicitly in BIOS Setup or by similar means. No method of resetting BIOS configuration settings to default values will affect either the Administrator or User passwords.

1. Power down the server. For safety, unplug the power cord(s)
2. Remove the system top cover
3. Move the "Password Clear" jumper from pins 1–2 (default) to pins 2–3 (password clear position)
4. Re-install the system top cover and re-attach the power cords
5. Power up the server and access the <F2> BIOS Setup utility
6. Verify the password clear operation was successful by viewing the Error Manager screen. Two errors should be logged:
  - 5221 Passwords cleared by jumper
  - 5224 Password clear jumper is set
7. Exit the BIOS Setup utility and power down the server. For safety, remove the AC power cords
8. Remove the system top cover and move the "Password Clear" jumper back to pins 1–2 (default)
9. Re-install the system top cover and reattach the AC power cords.
10. Power up the server
11. Strongly recommended: Boot into <F2> BIOS Setup immediately, go to the Security tab and set the Administrator and User passwords if you intend to use BIOS password protection

### 6.2.3 Management Engine (ME) Firmware Force Update Jumper Block

When the ME Firmware Force Update jumper is moved from its default position, the ME is forced to operate in a reduced minimal operating capacity. This jumper should only be used if the ME firmware has gotten corrupted and requires re-installation. The following procedure should be followed.

---

**Note:** System Update files are included in the System Update Packages (SUP) posted to the following Intel web site. <https://www.intel.com/content/www/us/en/support/products/89017/server-products/server-systems/intel-server-system-r1000wf-family.html>

---

1. Turn off the system.
2. Remove the AC power cords

---

**Note:** If the ME FRC UPD jumper is moved with AC power applied to the system, the ME will not operate properly.

---

3. Remove the system top cover
4. Move the "ME FRC UPD" Jumper from pins 1–2 (default) to pins 2–3 (Force Update position)
5. Re-install the system top cover and re-attach the AC power cords
6. Power on the system
7. Boot to the EFI shell
8. Change directories to the folder containing the update files
9. Update the ME firmware using the following command:
  - iflash32 /u /ni <version#>\_ME.cap
10. When the update has successfully completed, power off the system
11. Remove the AC power cords
12. Remove the system top cover

13. Move the “ME FRC UPD” jumper back to pins 1–2 (default)
14. Re-attach the AC power cords
15. Power on system

#### 6.2.4 BMC Force Update Jumper Block

The BMC Force Update jumper is used to put the BMC in Boot Recovery mode for a low-level update. It causes the BMC to abort its normal boot process and stay in the boot loader without executing any Linux code.

This jumper should only be used if the BMC firmware has gotten corrupted and requires re-installation. The following procedure should be followed:

1. Turn off the system.
2. Remove the AC power cords

---

**Note:** If the BMC FRC UPD jumper is moved with AC power applied to the system, the BMC will not operate properly.

---

3. Remove the system top cover
4. Move the “BMC FRC UPD” Jumper from pins 1–2 (default) to pins 2–3 (Force Update position)
5. Re-install the system top cover and re-attach the AC power cords
6. Power on the system
7. Boot to the EFI shell
8. Change directories to the folder containing the update files
9. Update the BMC firmware using the following command:  
`FWPIAUPD -u -bin -ni -b -o -pia -if=usb <file name.BIN>`
10. When the update has successfully completed, power off the system
11. Remove the AC power cords
12. Remove the system top cover
13. Move the “BMC FRC UPD” jumper back to pins 1–2 (default)
14. Re-attach the AC power cords
15. Power on system
16. Boot to the EFI shell
17. Change directories to the folder containing the update files
18. Re-install the board/system SDR data by running the FRUSDR utility
19. After the SDRs have been loaded, reboot the server

### 6.2.5 BIOS Recovery Jumper

When the BIOS Recovery jumper block is moved from its default pin position (pins 1–2), the system will boot using a backup BIOS image to the uEFI shell, where a standard BIOS update can be performed. See the BIOS update instructions that are included with System Update Packages (SUP) downloaded from Intel's download center web site. This jumper is used when the system BIOS has become corrupted and is non-functional, requiring a new BIOS image to be loaded on to the server board.

---

**Note:** The BIOS Recovery jumper is ONLY used to re-install a BIOS image in the event the BIOS has become corrupted. This jumper is NOT used when the BIOS is operating normally, and you need to update the BIOS from one version to another.

---

The following procedure should be followed.

1. Turn off the system
2. For safety, remove the AC power cords
3. Remove the system top cover
4. Move the "BIOS Recovery" jumper from pins 1–2 (default) to pins 2–3 (BIOS Recovery position)
5. Re-install the system top cover and re-attach the AC power cords
6. Power on the system
7. The system will automatically boot to the EFI shell. Update the BIOS using the standard BIOS update instructions provided with the system update package
8. After the BIOS update has successfully completed, power off the system. For safety, remove the AC power cords from the system
9. Remove the system top cover
10. Move the BIOS Recovery jumper back to pins 1–2 (default)
11. Re-install the system top cover and re-attach the AC power cords
12. Power on the system and access the <F2> BIOS Setup utility
13. Configure desired BIOS settings
14. Hit the <F10> key to save and exit the utility

### 6.2.6 Serial Port 'A' Configuration Jumper

Pin 7 of the RJ45 Serial A connector is configurable to support either a DSR (Default) signal or a DCD signal. Pin 7 signals are changed by moving the jumper on the jumper block labeled "J4A2", located next to the connector, from pins 1–2 (default) to pins 2–3.

## 7. System Service - FRU Replacement

This chapter provides instructions for the removal and installation of system components considered as field replaceable. Components within the system can only be serviced after the system has been powered off and AC power cords have been disconnected from the server system.

### Before You Begin

Before working with your server product, observe the safety and ESD precautions found in the Warnings section at the beginning of this manual.

### Tools and Supplies Needed

- Anti-static wrist strap and conductive foam pad (recommended)
- Phillips\* (cross head) screwdriver (#2 bit)
- Flat Head screwdriver
- T30 Torx bit screwdriver

### System Reference

All references to left, right, front, and back, assume the reader is facing the front of the system or the side opposite that of the external I/O connectors of the server board.

### 7.1 Replacing a System Fan

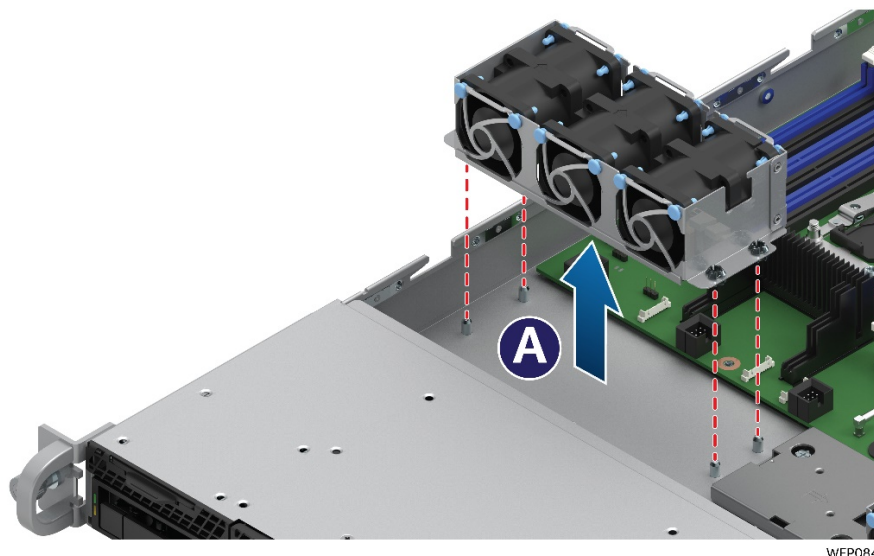
System fans used in the Intel Server System R1000WF product family are NOT hot-swappable.

1. Power off the system and remove the system top cover (see section 2.2.1).
2. Disconnect the cable of the target fan.

---

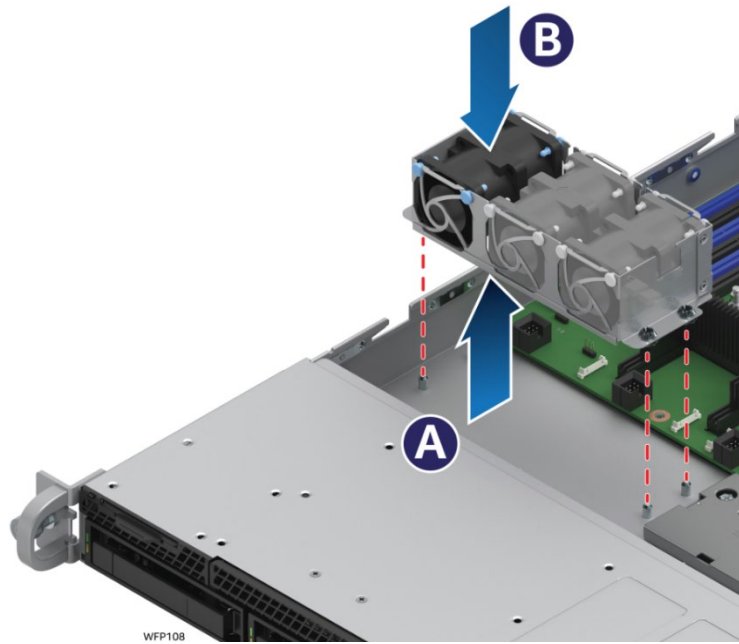
**Note:** disconnecting the cables from the remaining fans in the fan assembly is not required.

---

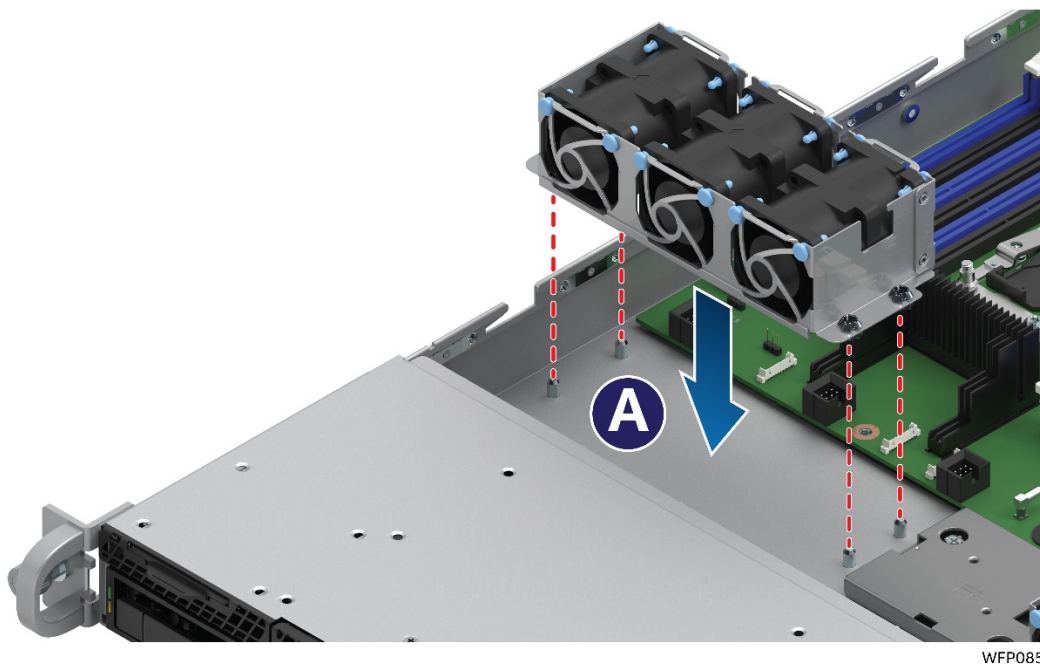


**Figure 100. System Fan Assembly Removal**

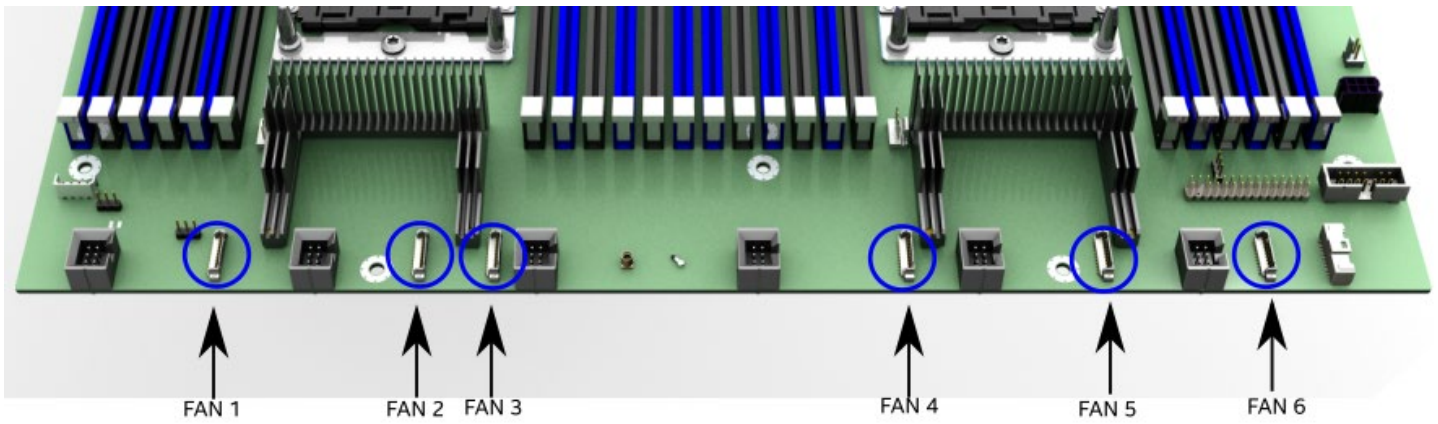
3. Lift the system fan assembly up and away from the chassis.



4. From the bottom of the fan assembly, push out the target fan (see Letter "A")
5. Locate the replacement fan.
6. Install the replacement fan into the fan module assembly, ensuring all rubber guides are in place and the cable is located on the side closest to the server board. (See Letter "B").



7. Align the fan module assembly mounting holes with pins on the chassis base and push down until firmly seated. Ensure that no fan cables are trapped beneath the fan module assembly.



**Figure 101. Connect System Fan Cables**

8. Attach the fan cable to the fan connector on the server board.
9. Ensure that all fan cables are securely connected.

## 7.2 Replacing the System Battery

The battery on the server board powers the Real Time Clock for up to 10 years in the absence of power. When the battery starts to weaken, it loses voltage, and stored server settings and system clock and date settings maybe lost.

Battery Specification:

- Lithium
- 3V
- Coin CR-2032

Contact your customer service representative or dealer for a list of approved devices.

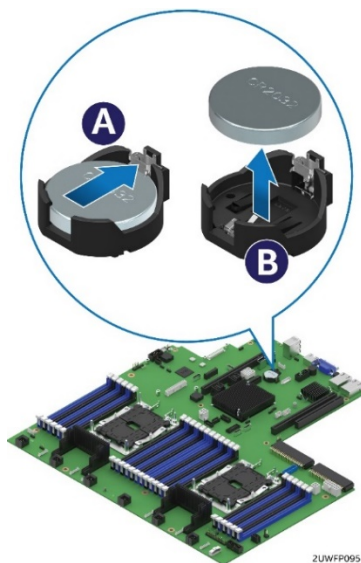
**Warning:** Danger of explosion if battery is incorrectly replaced. Replace only with the same or equivalent type recommended by the equipment manufacturer. Discard used batteries according to manufacturer's instructions.

**Advarsel:** Lithiumbatteri - Eksplosionsfare ved fejlagtig håndtering. Udskiftning må kun ske med batteri af samme fabrikat og type. Levér det brugte batteri tilbage til leverandøren.

**Advarsel:** Lithiumbatteri - Eksplosjonsfare. Ved utskifting benyttes kun batteri som anbefalt av apparatfabrikanten. Brukt batteri returneres apparatleverandøren.

**Warning:** Explosionsfara vid felaktigt batteribyte. Använd samma batterityp eller en ekvivalent typ som rekommenderas av apparattillverkaren. Kassera använt batteri enligt fabrikantens instruktion.

**Varoitus:** Paristo voi räjähtää, jos se on virheellisesti asennettu. Vaihda paristo ainoastaan laitevalmistajan suosittelemaan tyyppiin. Hävitä käytetty paristo valmistajan ohjeiden mukaisesti.



**Figure 102. Replacing the Backup Battery**

1. Power off the system and remove the system top cover (see Section 2.2.1).
2. Locate the battery on the server board.
3. Gently press the metal clip as shown to release the battery (see Letter "A").
4. Remove the battery from the plastic socket (see Letter "B").
5. Dispose of the battery according to local ordinance.
6. Remove the new lithium battery from its package and being careful to observe the correct polarity, insert it in to the battery socket.

**Note:** After replacing the battery, use the <F2> BIOS Setup Utility to reset and save all BIOS Setup options.

## 7.3 Rack Handles – Installation / Removal

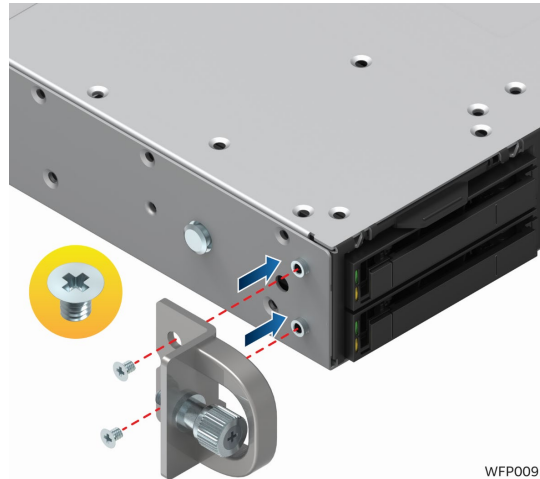
The system includes a set of rack handles designed to secure a system into a rack or cabinet and to aid with pulling systems from or pushing systems into a rack or cabinet.

---

**Note:** The system should never be carried solely by the rack handles. Intel recommends carrying the system using two people or to use a cart when moving the system from one location to another.

---

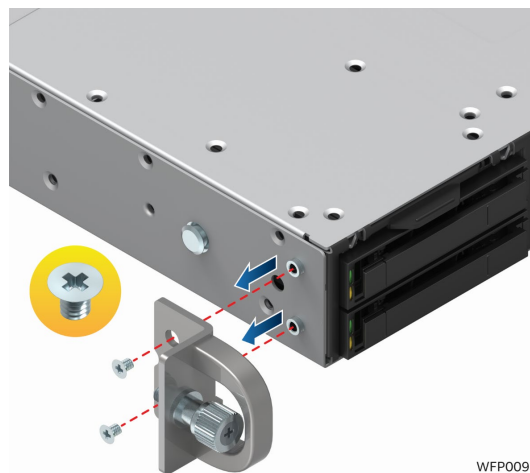
### 7.3.1 Installing the Rack Handles



**Figure 103. Installing the Rack Handle**

1. Locate the rack handles.
2. Align the rack handle with the two holes on the side of the server system.
3. Attach the rack handle to the server system with two screws using 8 in-lb. torque.

### 7.3.2 Removing the Rack Handles



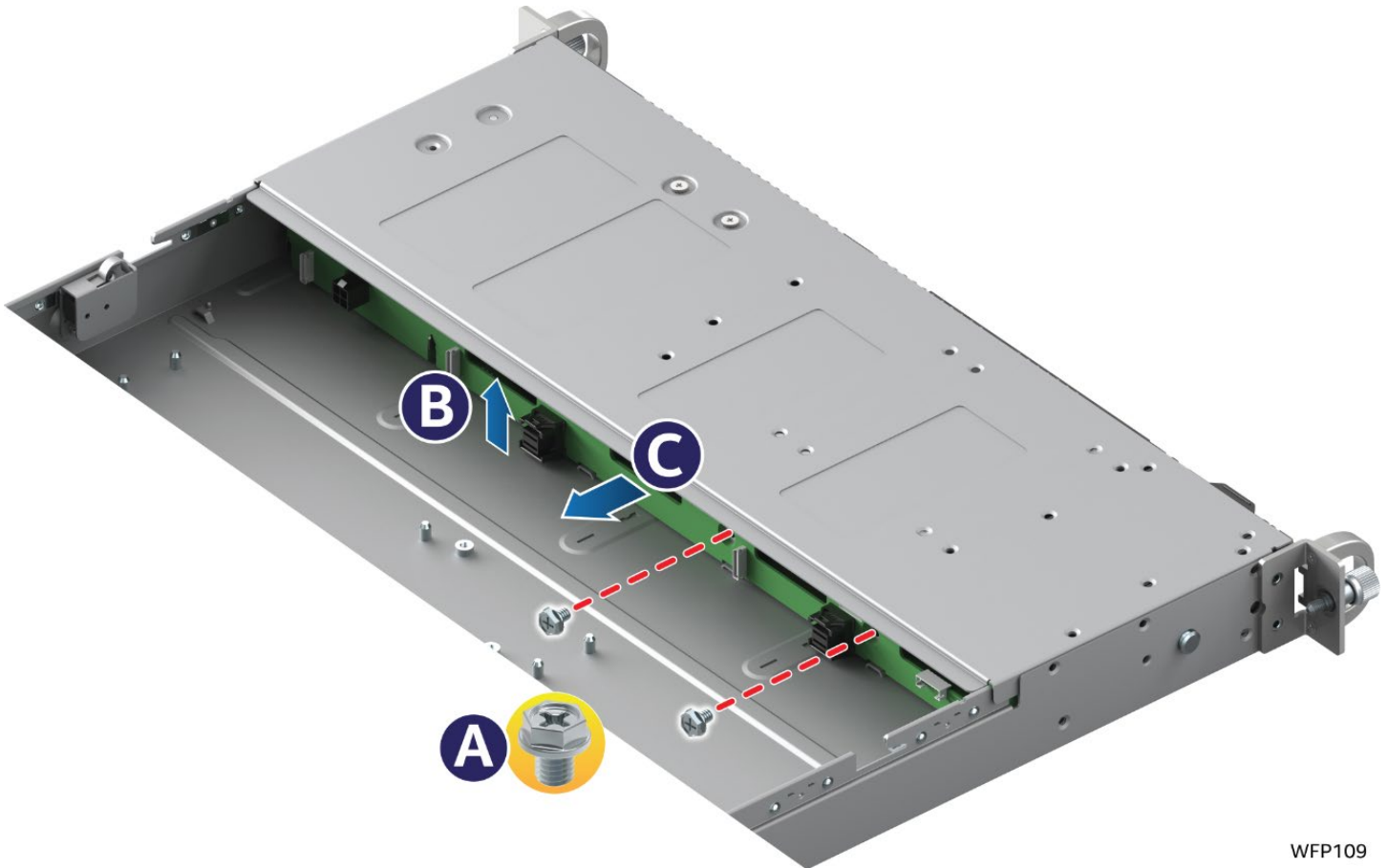
**Figure 104. Removing the Rack Handle**

Remove the two screws holding the rack handle to the chassis.



## 7.4 Replacing a Backplane

### 7.4.1 Removing the Backplane

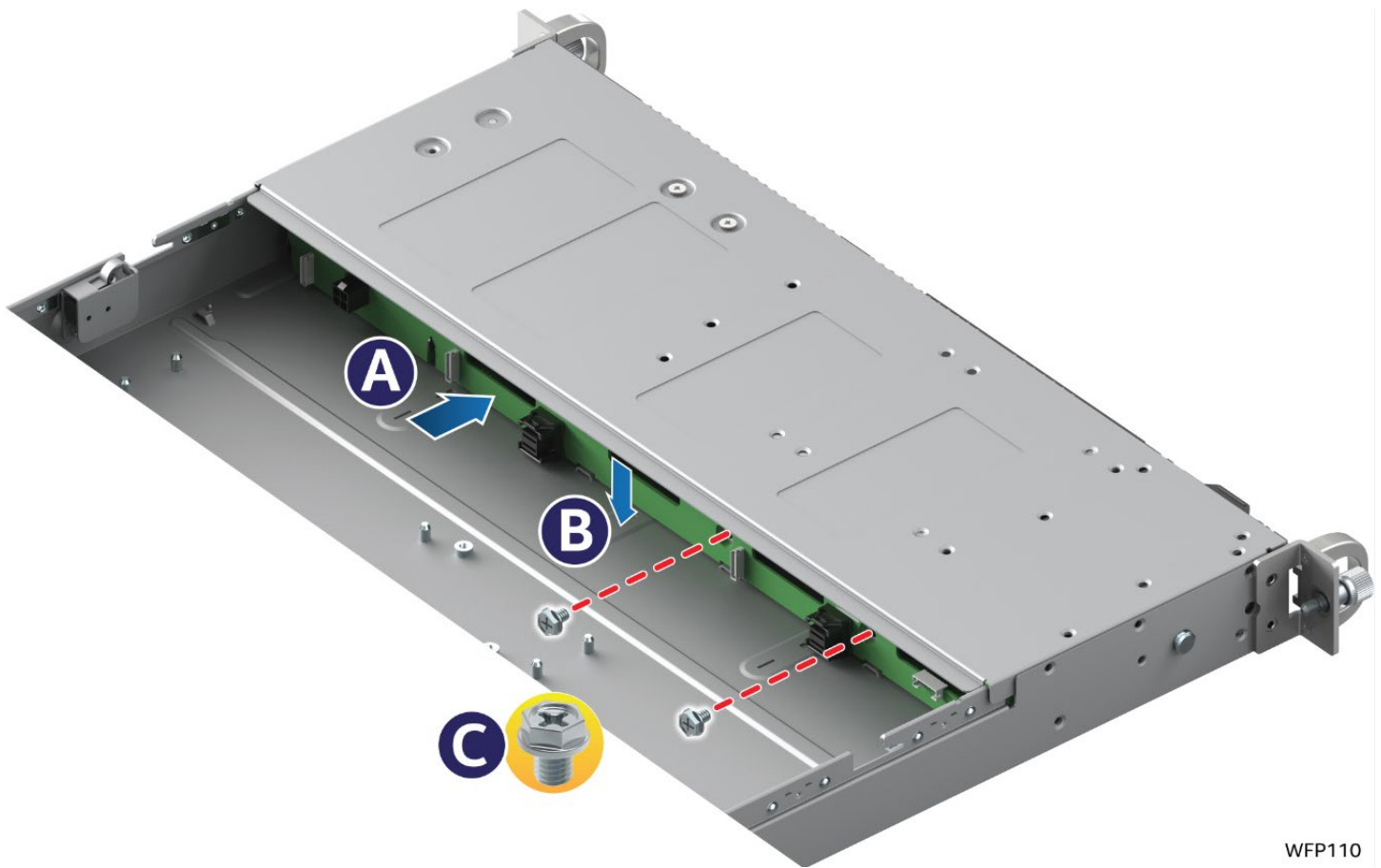


WFP109

**Figure 105. Removing the Backplane**

1. Power off the system and remove the system top cover (see Section 2.2.1).
2. Remove all hot-swap drive carriers, regardless of whether a drive is installed in the carrier.
3. Disconnect all cables from the backplane.
4. Remove all fastener screws securing the backplane to drive bay (see Letter "A").
5. Slide the backplane up from the bottom of the chassis (see Letter "B").
6. Remove the backplane from the server chassis (see Letter "C").

## 7.4.2 Installing the Backplane



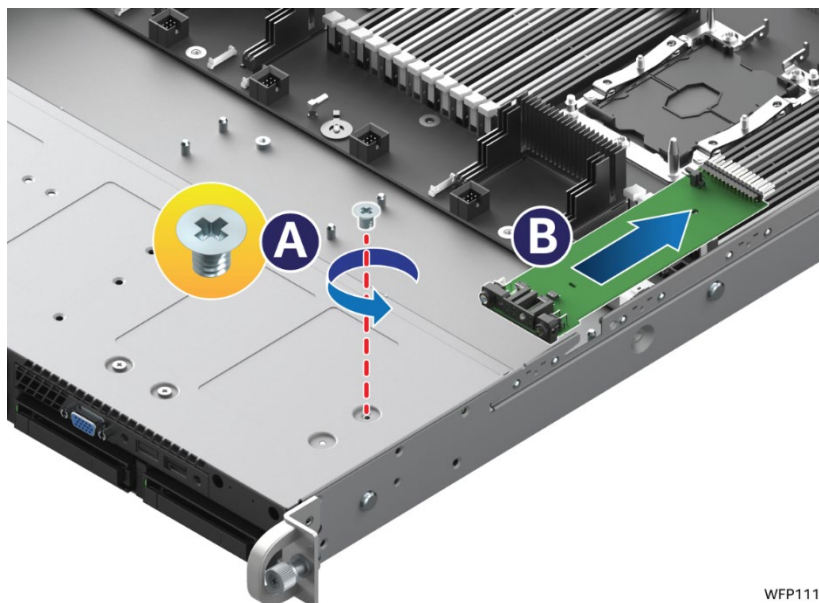
WFP110

**Figure 106. Installing the Backplane**

1. Locate the replacement 1U backplane.
2. Hold the backplane only by the edges. Do not push or pull on any components on the backplane. Position the backplane to the server system guides at the front of the server system (see Letter "A").
3. Slide the backplane down to lock it into place (see Letter "B").
4. Secure the backplane with the fastener screws as shown (see Letter "C").
5. Reinstall the hot-swap drive carriers.

## 7.5 Replacing the Standard Front Control Panel

### 7.5.1 Standard Front Control Panel Removal

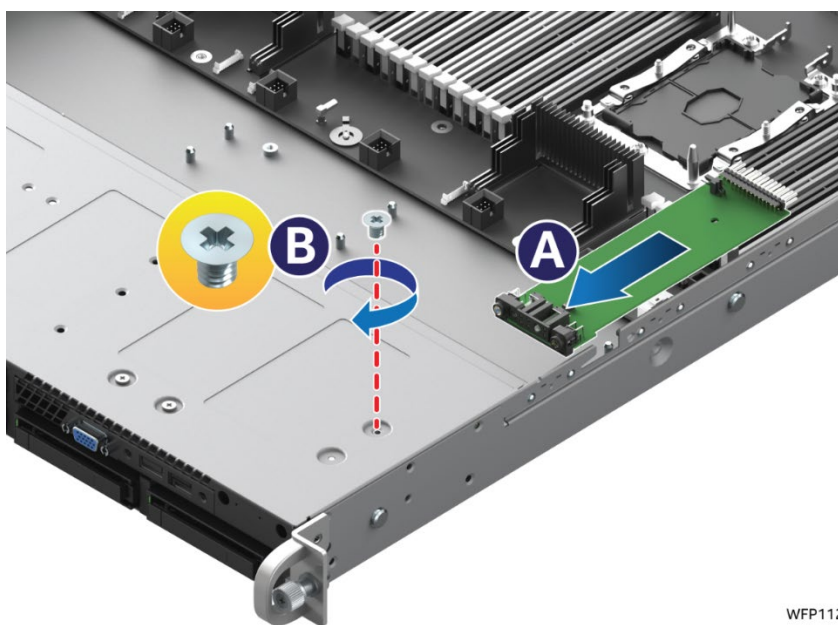


WFP111

**Figure 107. Standard Front Control Panel Removal**

1. Power off the system and remove all power cords.
2. Remove the system top cover (see Section 2.2.1).
3. Remove the air duct (see Section 2.3.1).
4. Remove the right system fan module assembly (see Section 7.1).
5. From the server board, disconnect the 30-pin front panel cable.
6. Remove the screw securing the Control Panel assembly to the chassis (see Letter "A").
7. Remove the Control Panel board from the chassis (see Letter "B").

### 7.5.2 Standard Front Control Panel Installation



WFP112

**Figure 108. Standard Front Control Panel Installation**

1. Locate and remove the replacement Control Panel board from its packaging.
2. Install the Control Panel board into the chassis (see Letter "A").

**Note:** Ensure the plastic gasket over the Control Panel buttons is securely in place before installing the Control Panel board into the drive bay module.

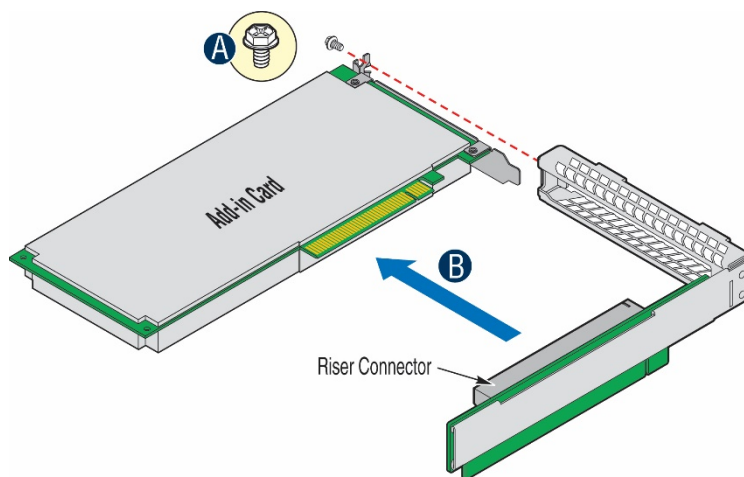
---

3. Connect the 30-pin cable to the new Control Panel.
4. The Control Panel is properly positioned when the buttons are protruding from the Control Panel face plate on the front of the drive bay module and the screw holes on the top of the assembly are aligned.
5. Using a single screw, secure the Control Panel Assembly to the drive bay module (8 in/lb. torque) (see Letter "B").
6. Connect the other end of the front panel cable to the matching 30-pin connector on the server board.
7. Install system fan module assembly (see Section 7.1).
8. Install air duct (see Section 2.3.2).

## 7.6 Replacing a PCIe\* Add-in Card

### 7.6.1 PCIe\* Add-in Card Removal

1. Remove the PCI riser assembly from the system.



AF004383

**Figure 109. Removing a PCI Add-In Card**

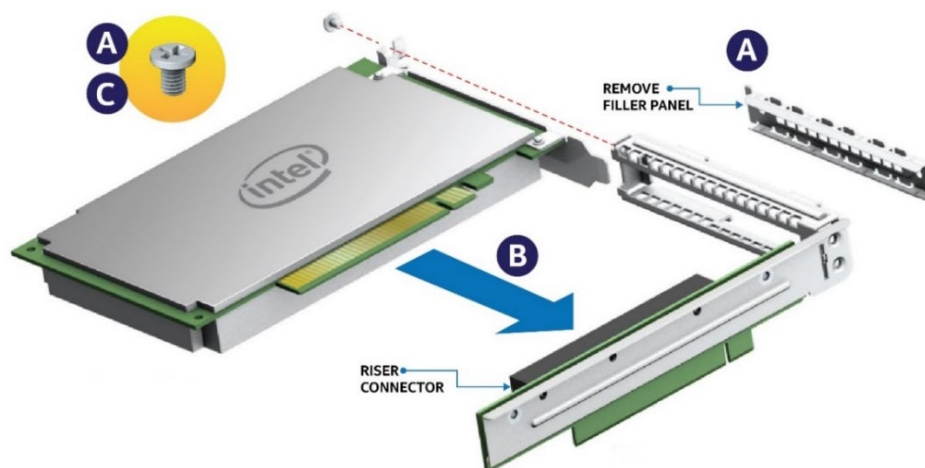
2. Remove the screw as shown (see letter "A").
3. Remove the PCI add-in card from the riser card connector (see letter "B").

---

**Note:** If not replacing the add-in card with a new one, make sure that all empty add-in card slot has a filler panel installed.

---

### 7.6.2 PCIe\* Add-in Card Installation



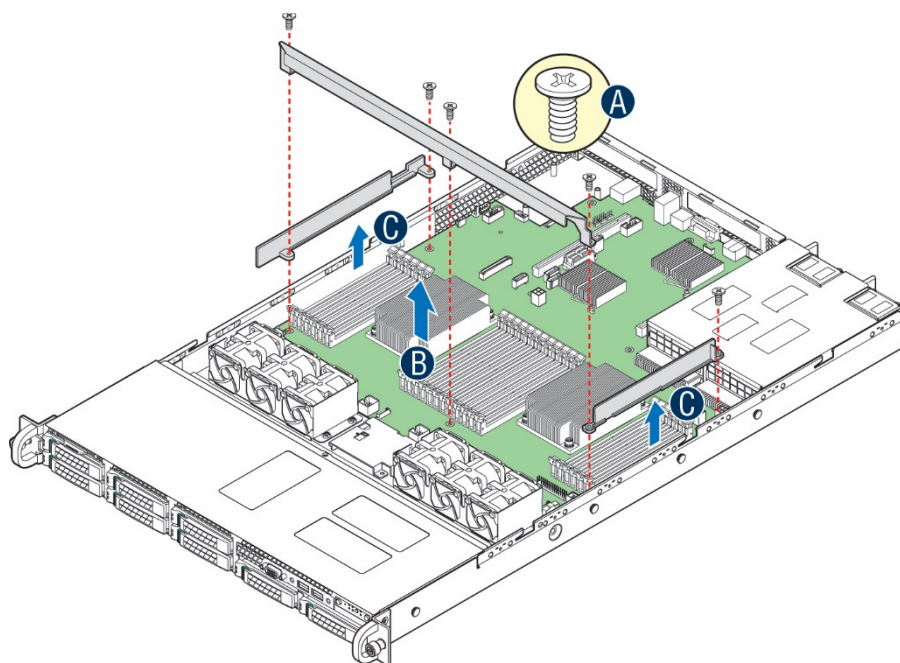
**Figure 110. PCI Add-In Card Installation**

1. If present, remove the filler panel from the add-in card slot and remove the fastener screw as shown (see Letter "A").
2. Insert the add-in card until it is fully seated inside the PCI slot on the riser card (see Letter "B").
3. Secure the add-in card to the riser bracket with the fastener screw as shown (see Letter "C").

## 7.7 Replacing the Server Board

### 7.7.1 Server Board Removal

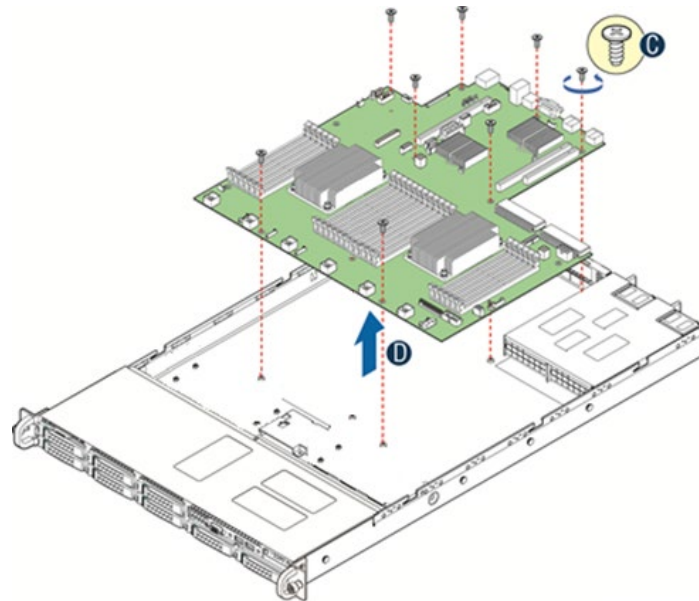
1. Power off system and remove power cords from each power supply module.
2. Disconnect all externally attached cables.
3. Remove the system cover (see Section 2.2.1).
4. Remove power supply modules (see Section 3.1.2).
5. Remove air duct (see section 2.3.1).
6. Disconnect all the system fan cables.
7. Remove both fan module assemblies from the chassis (see Section 7.1).
8. Disconnect all cables attached to add-in PCIe\* add-cards and I/O modules.
9. Remove riser card assemblies (see Section 2.7.1).
10. Remove all options installed onto the server board including (if installed): OCP Module, Intel® SAS RAID Module and mounting stand-offs, Intel® RAID 5 option key, Intel® RMM 4 Lite key, TPM Module, eUSB SSD and mounting stand-offs.
11. Remove Processors (see Section 2.4.3).
12. Remove all DIMMs (see Section 2.5.2).
13. Disconnect all cables attached to connectors on the server board.



AF006370

**Figure 111. Server Board Removal**

14. Remove the three fastener screws securing the Chassis Support Bracket to the server board (see Letter "A").
15. Remove the Chassis Support Bracket (see Letter "B").
16. Loosen the fastener screws securing the Air Duct Sidewalls to the server board (see Letter "C").
17. Remove the two air duct sidewalls from the chassis.



**Figure 112. Server Board Lifting**

18. Remove the eight fastener screws used to secure the server board to the chassis (see Letter “C”).
19. Carefully lift server board up and away from the chassis (see Letter “D”) and place it into an anti-static bag.

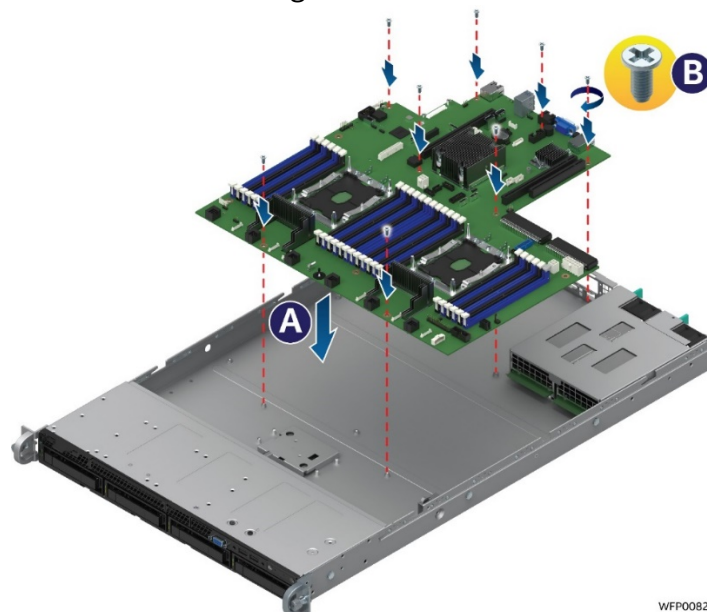
### 7.7.2 Server Board Installation

---

**Note:** Follow ESD precautions outlined at the beginning of this manual.

---

1. Remove the server board from its anti-static bag.



WFP0082

2. Holding the server board by its edges, carefully lower the server board into the chassis so that the rear I/O connectors of the server board align with and are fully seated into the matching holes on the chassis back panel and each server board mounting hole is aligned with a threaded chassis standoff.
3. The server board is accurately placed when the two screw holes nearest the front edge of the server board (See Letter “A”) sit securely onto the shouldered chassis standoffs.
4. Using 8 in-lb. torque, fasten down the server board with eight (8) screws in the positions

5. Re-attach all cables previously removed from the server board.
6. Install processor(s) (see Section 2.4.2).
7. Install DIMMs (see Section 2.5.1).
8. Re-Install all options previously removed from the server board.
9. Re-Install riser card assemblies (see Section 2.7).
10. Re-attach all internal cables previously detached from add-in cards and modules.
11. Re-install system fan module assemblies (see Section 7.1).
12. Re-install air duct (see Section 2.3.2).
13. If installed, re-attach cables to any device mounted to the air duct.
14. Install power supply module(s) (see Section 1.3.1).
15. Install system cover (see Section 2.2.2).



## Appendix A. Getting Help

---

If you encounter an issue with your server system, follow these steps to obtain support:

Visit the following Intel support web page: <http://www.intel.com/support/>

This web page provides 24x7 support when you need it to get the latest and most complete technical support information on all Intel Enterprise Server and Storage Platforms. Information available at the support site includes:

- Latest BIOS, firmware, drivers and utilities
- Product documentation, installation and quick start guides
- Full product specifications, technical advisories and errata
- Compatibility documentation for memory, hardware add-in cards, chassis support matrix and operating systems
- Server and chassis accessory parts list for ordering upgrades or spare parts
- A searchable knowledgebase to search for product information throughout the support site

If you are still unable to obtain a solution to your issue, send an email to Intel's technical support center using the online form available at:

[http://www.intel.com/p/en\\_US/support/contactsupport](http://www.intel.com/p/en_US/support/contactsupport)

Lastly, you can contact an Intel support representative using one of the support phone numbers available at: <http://www.intel.com/support/feedback.htm?group=server> (charges may apply).

Intel also offers Channel Program members around-the-clock 24x7 technical phone support on Intel® server boards, server chassis, server RAID controller cards, and Intel® Server Management at:

<http://www.intel.com/reseller/>.

---

**Note:** You will need to log in to the Reseller site to obtain the 24x7 number.

---

### Warranty Information

To obtain warranty information, visit the following Intel web site:

[http://www.intel.com/p/en\\_US/support/warranty](http://www.intel.com/p/en_US/support/warranty)

## Appendix B. System Cable Routing Diagrams

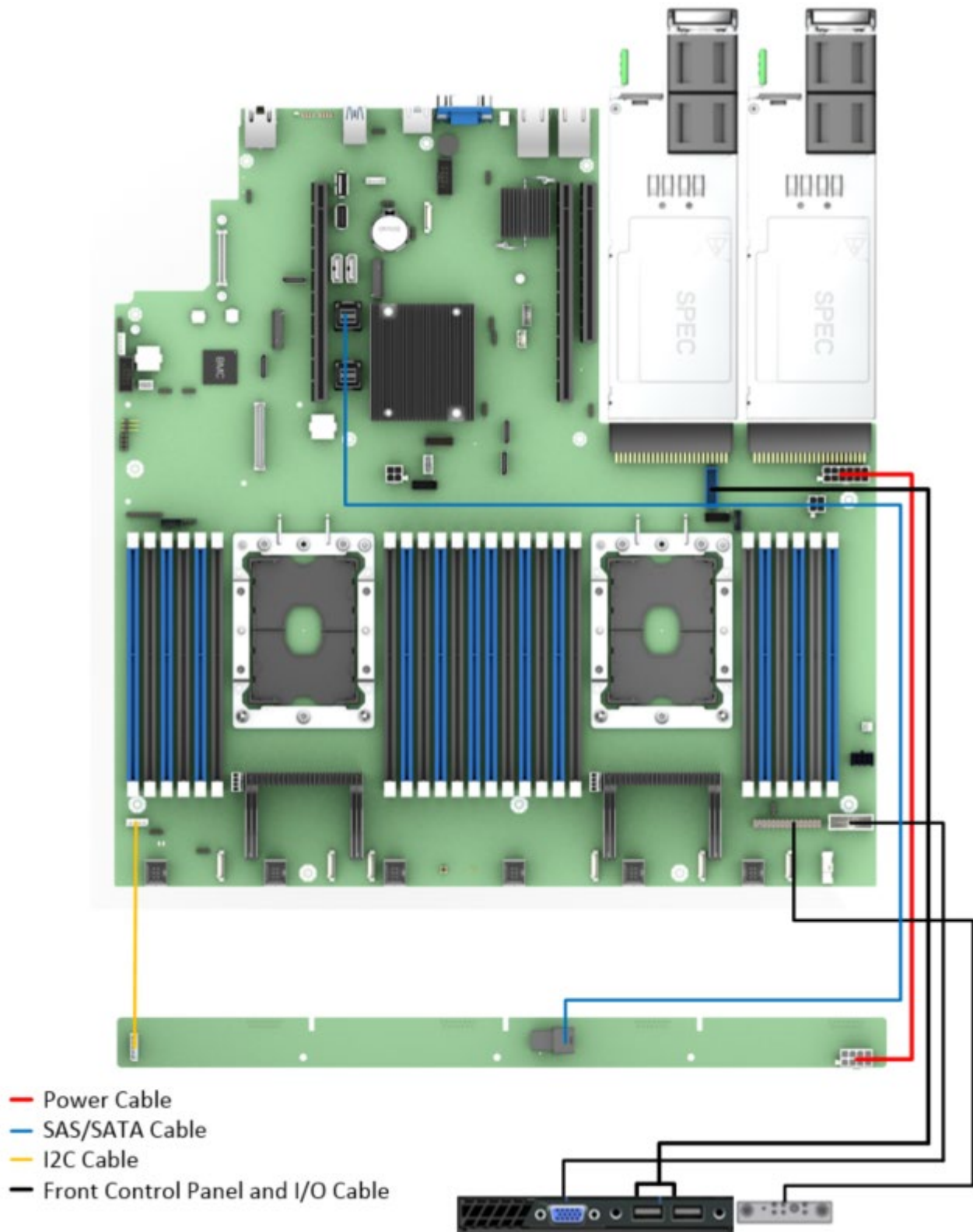


Figure 113. Intel® Server System R1304WFxxxx Cable Routing

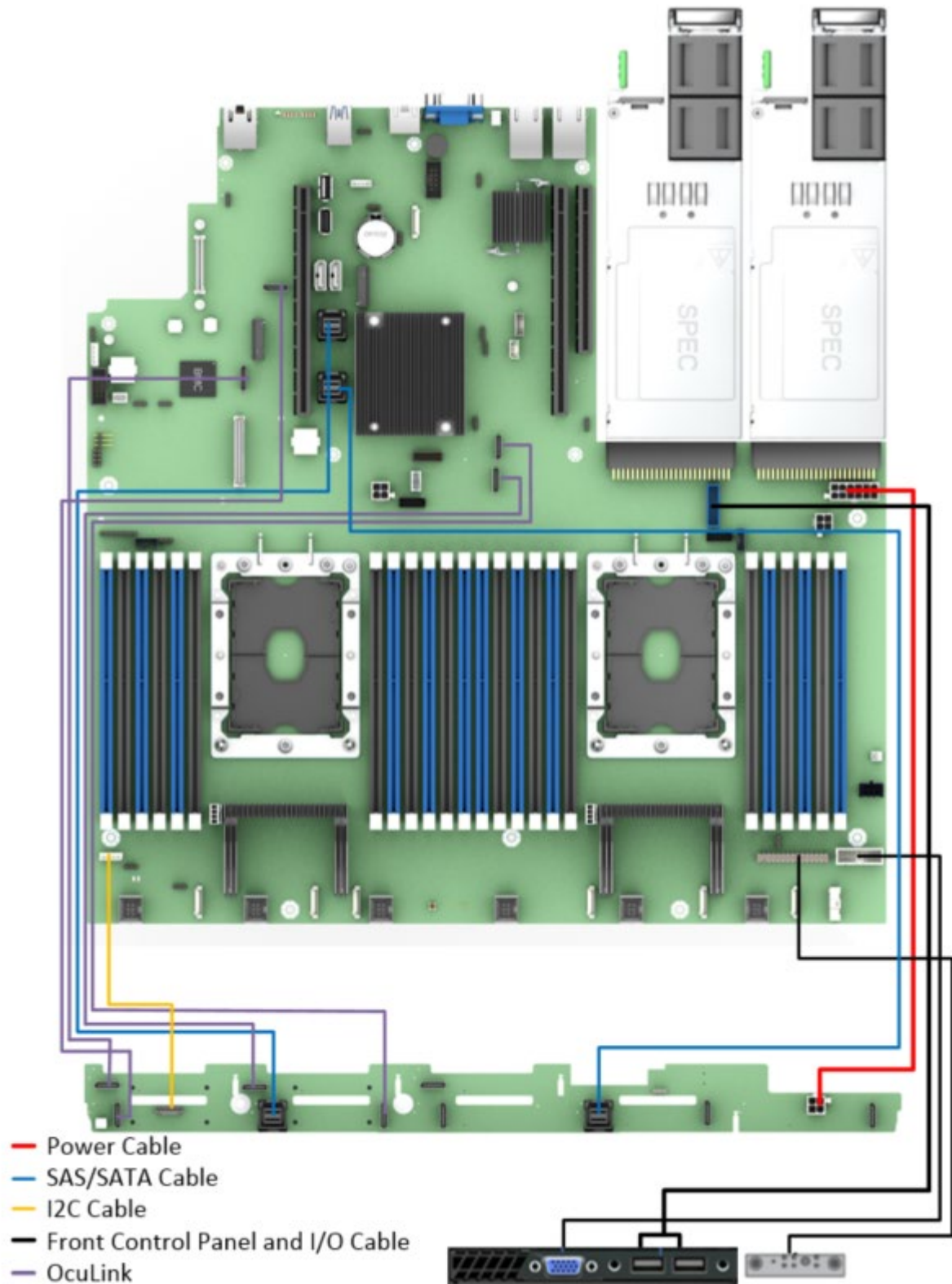


Figure 114. Intel Server System R1208WFxxxx Cable Routing

## Appendix C. System Status LED Operating States and Definition

The server board includes a bi-color System Status LED. The System Status LED on the server board is tied directly to the System Status LED on the front panel. This LED indicates the current health of the server. Possible LED states include solid green, blinking green, blinking amber, and solid amber.

When the server is powered down (transitions to the DC-off state or S5), the BMC is still on standby power and retains the sensor and front panel status LED state established before the power-down event.

When AC power is first applied to the system, the status LED turns solid amber and then immediately changes to blinking green to indicate that the BMC is booting. If the BMC boot process completes with no errors, the status LED will change to solid green.

**Table 4. System Status LED State Definitions**

Color	State	Criticality	Description
Off	System is not operating	Not ready	<ul style="list-style-type: none"> <li>System is powered off (AC and/or DC).</li> <li>System is in EuP Lot6 Off Mode.</li> <li>System is in S5 Soft-Off State.</li> </ul>
Green	Solid on	Ok	<p>Indicates that the System is running (in S0 State) and its status is 'Healthy'. The system is not exhibiting any errors. AC power is present and BMC has booted and manageability functionality is up and running.</p> <p>After a BMC reset, and in conjunction with the Chassis ID solid ON, the BMC is booting Linux*. Control has been passed from BMC uBoot to BMC Linux* itself. It will be in this state for ~10~20 seconds</p>
Green	~1 Hz blink	Degraded - system is operating in a degraded state although still functional, or system is operating in a redundant state but with an impending failure warning	<ul style="list-style-type: none"> <li>System degraded:</li> <li>Redundancy loss such as power-supply or fan. Applies only if the associated platform sub-system has redundancy capabilities.</li> <li>Fan warning or failure when the number of fully operational fans is less than minimum number needed to cool the system.</li> <li>Non-critical threshold crossed – Temperature (including HSBP temp), voltage, input power to power supply, output current for main power rail from power supply and Processor Thermal Control (Therm Ctrl) sensors.</li> <li>Power supply predictive failure occurred while redundant power supply configuration was present.</li> <li>Unable to use all of the installed memory (more than 1 DIMM installed).</li> <li>Correctable Errors over a threshold and migrating to a spare DIMM (memory sparing). This indicates that the system no longer has spared DIMMs (a redundancy lost condition). Corresponding DIMM LED lit.</li> <li>In mirrored configuration, when memory mirroring takes place and system loses memory redundancy.</li> <li>Battery failure.</li> <li>BMC executing in uBoot. (Indicated by Chassis ID blinking at 3Hz). System in degraded state (no manageability). BMC uBoot is running but has not transferred control to BMC Linux*. Server will be in this state 6–8 seconds after BMC reset while it pulls the Linux* image into flash.</li> <li>BMC Watchdog has reset the BMC.</li> <li>Power Unit sensor offset for configuration error is asserted.</li> <li>HDD HSC is off-line or degraded.</li> </ul>
Amber	~1 Hz blink	Non-critical - System is operating in a degraded state with an impending failure warning, although still functioning	<ul style="list-style-type: none"> <li>Non-fatal alarm – system is likely to fail:</li> <li>Critical threshold crossed – Voltage, temperature (including HSBP temp), input power to power supply, output current for main power rail from power supply and PROCHOT (Therm Ctrl) sensors.</li> <li>VRD Hot asserted.</li> <li>Minimum number of fans to cool the system not present or failed</li> <li>Hard drive fault</li> <li>Power Unit Redundancy sensor – Insufficient resources offset (indicates not enough power supplies present)</li> </ul>

Color	State	Criticality	Description
			<ul style="list-style-type: none"> <li>• In non-sparing and non-mirroring mode if the threshold of correctable errors is crossed within the window</li> </ul>
Amber	Solid on	Critical, non-recoverable – System is halted	<p>Fatal alarm – system has failed or shutdown:</p> <ul style="list-style-type: none"> <li>• CPU CATERR signal asserted</li> <li>• MSID mismatch detected (CATERR also asserts for this case).</li> <li>• CPU 1 is missing</li> <li>• CPU Thermal Trip</li> <li>• No power good – power fault</li> <li>• DIMM failure when there is only 1 DIMM present and hence no good memory present.</li> <li>• Runtime memory uncorrectable error in non-redundant mode.</li> <li>• DIMM Thermal Trip or equivalent</li> <li>• SSB Thermal Trip or equivalent</li> <li>• CPU ERR2 signal asserted</li> <li>• BMC/Video memory test failed. (Chassis ID shows blue/solid-on for this condition)</li> <li>• Both uBoot BMC FW images are bad. (Chassis ID shows blue/solid-on for this condition)</li> <li>• 240VA fault</li> </ul> <p>Fatal Error in processor initialization:</p> <ul style="list-style-type: none"> <li>• Processor family not identical</li> <li>• Processor model not identical</li> <li>• Processor core/thread counts not identical</li> <li>• Processor cache size not identical</li> <li>• Unable to synchronize processor frequency</li> <li>• Unable to synchronize QPI link frequency</li> <li>• Uncorrectable memory error in a non-redundant mode</li> </ul>

## Appendix D. POST Code Diagnostic LED Decoder Table

As an aid to assist in trouble shooting a system hang that occurs during a system's Power-On Self-Test (POST) process, the server board includes a bank of eight POST Code Diagnostic LEDs on the back edge of the server board as shown in the figure below.

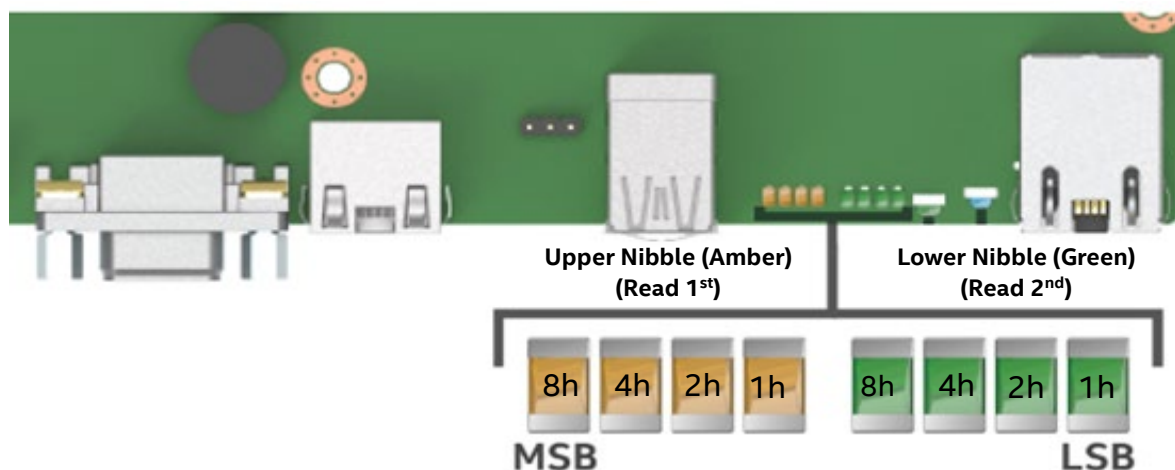
During the system boot process, Memory Reference Code (MRC) and System BIOS execute a number of memory initialization and platform configuration processes, each of which is assigned a specific hex POST code number.

As each routine is started, the given POST code number is displayed to the POST Code Diagnostic LEDs on the back edge of the server board.

During a POST system hang, the displayed post code can be used to identify the last POST routine that was run prior to the error occurring, helping to isolate the possible cause of the hang condition.

Each POST code is represented by eight LEDs; four green and four amber. The POST codes are divided into two nibbles, an upper nibble and a lower nibble. The upper nibble bits are represented by Amber Diagnostic LEDs and the lower nibble bits are represented by Green Diagnostics LEDs. If the bit is set in the upper and lower nibbles, the corresponding LED is lit. If the bit is clear, the corresponding LED is off.

**Note:** Diagnostic LEDs are best read and decoded when viewing the LEDs from the back of the system.



**Figure 115. POST Diagnostic LED Location**

In the following example, the BIOS sends a value of ACh to the diagnostic LED decoder. The LEDs are decoded as shown in Table 6.

**Table 5. POST Progress Code LED Example**

LEDs	Upper Nibble AMBER LEDs				Lower Nibble GREEN LEDs			
	MSB							LSB
	LED #7	LED #6	LED #5	LED #4	LED #3	LED #2	LED #1	LED #0
	8h	4h	2h	1h	8h	4h	2h	1h
Status	ON	OFF	ON	OFF	ON	ON	OFF	OFF
Results	1	0	1	0	1	1	0	0
	Ah				Ch			

Upper nibble bits = 1010b = Ah; Lower nibble bits = 1100b = Ch; the two are concatenated as ACh

## Early POST Memory Initialization MRC Diagnostic Codes

Memory Initialization at the beginning of POST includes multiple functions, including: discovery, channel training, validation that the DIMM population is acceptable and functional, initialization of the IMC and other hardware settings, and initialization of applicable RAS configurations.

The MRC Progress Codes are displays to the Diagnostic LEDs that show the execution point in the MRC operational path at each step.

**Table 6. MRC Progress Codes**

Checkpoint	Diagnostic LED Decoder								Description
	1 = LED On, 0 = LED Off								
	Upper Nibble (Amber)				Lower Nibble (Green)				
	MS B							LSB	
	8h	4h	2h	1h	8h	4h	2h	1h	
MRC Progress Codes									
<b>B0h</b>	1	0	1	1	0	0	0	0	Detect DIMM population
<b>B1h</b>	1	0	1	1	0	0	0	1	Set DDR4 frequency
<b>B2h</b>	1	0	1	1	0	0	1	0	Gather remaining SPD data
<b>B3h</b>	1	0	1	1	0	0	1	1	Program registers on the memory controller level
<b>B4h</b>	1	0	1	1	0	1	0	0	Evaluate RAS modes and save rank information
<b>B5h</b>	1	0	1	1	0	1	0	1	Program registers on the channel level
<b>B6h</b>	1	0	1	1	0	1	1	0	Perform the JEDEC defined initialization sequence
<b>B7h</b>	1	0	1	1	0	1	1	1	Train DDR4 ranks
<b>B8h</b>	1	0	1	1	1	0	0	0	Initialize CLTT/OLTT
<b>B9h</b>	1	0	1	1	1	0	0	1	Hardware memory test and init
<b>BAh</b>	1	0	1	1	1	0	1	0	Execute software memory init
<b>BBh</b>	1	0	1	1	1	0	1	1	Program memory map and interleaving
<b>BCh</b>	1	0	1	1	1	1	0	0	Program RAS configuration
<b>BFh</b>	1	0	1	1	1	1	1	1	MRC is done

Should a major memory initialization error occur, preventing the system from booting with data integrity, a beep code is generated, the MRC will display a fatal error code on the diagnostic LEDs, and a system halt command is executed. Fatal MRC error halts do NOT change the state of the System Status LED, and they do NOT get logged as SEL events. The following table lists all MRC fatal errors that are displayed to the Diagnostic LEDs.

---

**Note:** Fatal MRC errors will display POST error codes that may be the same as BIOS POST progress codes displayed later in the POST process. The fatal MRC codes can be distinguished from the BIOS POST progress codes by the accompanying memory failure beep code of 3 long beeps as identified in Table 10.

---

**Table 7. MRC Fatal Error Codes**

Checkpoint	Diagnostic LED Decoder								Description
	1 = LED On, 0 = LED Off								
	Upper Nibble (Amber - Read 1st)				Lower Nibble (Green - Read 2nd)				
	MS B							LSB	
	8h	4h	2h	1h	8h	4h	2h	1h	
<b>MRC Fatal Error Codes</b>									
<b>E8h</b>	1	1	1	0	1	0	0	0	No usable memory error 01h = No memory was detected from SPD read, or invalid config that causes no operable memory. 02h = Memory DIMMs on all channels of all sockets are disabled due to hardware memtest error. 03h = No memory installed. All channels are disabled.
<b>E9h</b>	1	1	1	0	1	0	0	1	Memory is locked by Intel Trusted Execution Technology and is inaccessible
<b>EAh</b>	1	1	1	0	1	0	1	0	DDR4 channel training error 01h = Error on read DQ/DQS (Data/Data Strobe) init 02h = Error on Receive Enable 03h = Error on Write Leveling 04h = Error on write DQ/DQS (Data/Data Strobe)
<b>EBh</b>	1	1	1	0	1	0	1	1	Memory test failure 01h = Software memtest failure. 02h = Hardware memtest failed.
<b>EDh</b>	1	1	1	0	1	1	0	1	DIMM configuration population error 01h = Different DIMM types (RDIMM, LRDIMM) are detected installed in the system. 02h = Violation of DIMM population rules. 03h = The 3rd DIMM slot cannot be populated when QR DIMMs are installed. 04h = UDIMMs are not supported. 05h = Unsupported DIMM Voltage.
<b>EFh</b>	1	1	1	0	1	1	1	1	Indicates a CLTT table structure error



## BIOS POST Progress Codes

The following table provides a list of all POST progress codes.

**Table 8. POST Progress Codes**

Checkpoint	Diagnostic LED Decoder								Description
	1 = LED On, 0 = LED Off								
	Upper Nibble (Amber - Read 1 <sup>st</sup> )				Lower Nibble (Green - Read 2 <sup>nd</sup> )				
	MSB							LSB	
8h	4h	2h	1h	8h	4h	2h	1h		
SEC Phase									
01h	0	0	0	0	0	0	0	1	First POST code after CPU reset
02h	0	0	0	0	0	0	1	0	Microcode load begin
03h	0	0	0	0	0	0	1	1	CRAM initialization begin
04h	0	0	0	0	0	1	0	0	EI Cache When Disabled
05h	0	0	0	0	0	1	0	1	SEC Core at Power on Begin
06h	0	0	0	0	0	1	1	0	Early CPU initialization during Sec Phase.
UPI RC (Fully leverage without platform change)									
A1h	1	0	1	0	0	0	0	1	Collect info such as SBSP, Boot Mode, Reset type etc
A3h	1	0	1	0	0	0	1	1	Setup minimum path between SBSP & other sockets
A7h	1	0	1	0	0	1	1	1	Topology discovery and route calculation
A8h	1	0	1	0	1	0	0	0	Program final route
A9h	1	0	1	0	1	0	0	1	Program final IO SAD setting
AAh	1	0	1	0	1	0	1	0	Protocol layer and other uncore settings
ABh	1	0	1	0	1	0	1	1	Transition links to full speed operation
ACh	1	0	1	0	1	1	0	0	Phy layer setting
ADh	1	0	1	0	1	1	0	1	Link layer settings
A Eh	1	0	1	0	1	1	1	0	Coherency settings
AFh	1	0	1	0	1	1	1	1	UPI initialization done
07h	0	0	0	0	0	1	1	1	Early SB initialization during Sec Phase.
08h	0	0	0	0	1	0	0	0	Early NB initialization during Sec Phase.
09h	0	0	0	0	1	0	0	1	End Of Sec Phase.
0Eh	0	0	0	0	1	1	1	0	Microcode Not Found.
0Fh	0	0	0	0	1	1	1	1	Microcode Not Loaded.
PEI Phase									
10h	0	0	0	1	0	0	0	0	PEI Core
11h	0	0	0	1	0	0	0	1	CPU PEIM
15h	0	0	0	1	0	1	0	1	NB PEIM
19h	0	0	0	1	1	0	0	1	SB PEIM
MRC Progress Codes									
31h	0	0	1	1	0	0	0	1	Memory Installed

Checkpoint	Diagnostic LED Decoder								Description
	1 = LED On, 0 = LED Off								
	Upper Nibble (Amber - Read 1 <sup>st</sup> )				Lower Nibble (Green - Read 2 <sup>nd</sup> )				
	MSB							LSB	
8h	4h	2h	1h	8h	4h	2h	1h		
32h	0	0	1	1	0	0	1	0	CPU PEIM (CPU Init)
33h	0	0	1	1	0	0	1	1	CPU PEIM (Cache Init)
4Fh	0	1	0	0	1	1	1	1	Dxe IPL started
DXE Phase									
60h	0	1	1	0	0	0	0	0	DXE Core started
61h	0	1	1	0	0	0	0	1	DXE NVRAM Init
62h	0	1	1	0	0	0	1	0	DXE Setup Init
63h	0	1	1	0	0	0	1	1	DXE CPU Init
65h	0	1	1	0	0	1	0	1	DXE CPU BSP Select
66h	0	1	1	0	0	1	1	0	DXE CPU AP Init
68h	0	1	1	0	1	0	0	0	DXE PCI Host Bridge Init
69h	0	1	1	0	1	0	0	1	DXE NB Init
6Ah	0	1	1	0	1	0	1	0	DXE NB SMM Init
70h	0	1	1	1	0	0	0	0	DXE SB Init
71h	0	1	1	1	0	0	0	1	DXE SB SMM Init
72h	0	1	1	1	0	0	1	0	DXE SB devices Init
78h	0	1	1	1	1	0	0	0	DXE ACPI Init
79h	0	1	1	1	1	0	0	1	DXE CSM Init
80h	1	0	0	0	0	0	0	0	DXE BDS Started
81h	1	0	0	0	0	0	0	1	DXE BDS connect drivers
82h	1	0	0	0	0	0	1	0	DXE PCI Bus begin
83h	1	0	0	0	0	0	1	1	DXE PCI Bus HPC Init
84h	1	0	0	0	0	1	0	0	DXE PCI Bus enumeration
85h	1	0	0	0	0	1	0	1	DXE PCI Bus resource requested
86h	1	0	0	0	0	1	1	0	DXE PCI Bus assign resource
87h	1	0	0	0	0	1	1	1	DXE CON_OUT connect
88h	1	0	0	0	1	0	0	0	DXE CON_IN connect
89h	1	0	0	0	1	0	0	1	DXE SIO Init
8Ah	1	0	0	0	1	0	1	0	DXE USB start
8Bh	1	0	0	0	1	0	1	1	DXE USB reset
8Ch	1	0	0	0	1	1	0	0	DXE USB detect
8Dh	1	0	0	0	1	1	0	1	DXE USB enable
91h	1	0	0	1	0	0	0	1	DXE IDE begin
92h	1	0	0	1	0	0	1	0	DXE IDE reset

Checkpoint	Diagnostic LED Decoder								Description
	1 = LED On, 0 = LED Off								
	Upper Nibble (Amber - Read 1 <sup>st</sup> )				Lower Nibble (Green - Read 2 <sup>nd</sup> )				
	MSB							LSB	
8h	4h	2h	1h	8h	4h	2h	1h		
93h	1	0	0	1	0	0	1	1	DXE IDE detect
94h	1	0	0	1	0	1	0	0	DXE IDE enable
95h	1	0	0	1	0	1	0	1	DXE SCSI begin
96h	1	0	0	1	0	1	1	0	DXE SCSI reset
97h	1	0	0	1	0	1	1	1	DXE SCSI detect
98h	1	0	0	1	1	0	0	0	DXE SCSI enable
99h	1	0	0	1	1	0	0	1	DXE verifying SETUP password
9Bh	1	0	0	1	1	0	1	1	DXE SETUP start
9Ch	1	0	0	1	1	1	0	0	DXE SETUP input wait
9Dh	1	0	0	1	1	1	0	1	DXE Ready to Boot
9Eh	1	0	0	1	1	1	1	0	DXE Legacy Boot
9Fh	1	0	0	1	1	1	1	1	DXE Exit Boot Services
C0h	1	1	0	0	0	0	0	0	RT Set Virtual Address Map Begin
C2h	1	1	0	0	0	0	1	0	DXE Legacy Option ROM init
C3h	1	1	0	0	0	0	1	1	DXE Reset system
C4h	1	1	0	0	0	1	0	0	DXE USB Hot plug
C5h	1	1	0	0	0	1	0	1	DXE PCI BUS Hot plug
C6h	1	1	0	0	0	1	1	0	DXE NVRAM cleanup
C7h	1	1	0	0	0	1	1	1	DXE ACPI Enable
0h	0	0	0	0	0	0	0	0	Clear POST Code
S3 Resume									
40h	0	1	0	0	0	0	0	0	S3 Resume PEIM (S3 started)
41h	0	1	0	0	0	0	0	1	S3 Resume PEIM (S3 boot script)
42h	0	1	0	0	0	0	1	0	S3 Resume PEIM (S3 Video Repost)
43h	0	1	0	0	0	0	1	1	S3 Resume PEIM (S3 OS wake)
BIOS Recovery									
46h	0	1	0	0	0	1	1	0	PEIM, which detected forced Recovery condition
47h	0	1	0	0	0	1	1	1	PEIM, which detected User Recovery condition
48h	0	1	0	0	1	0	0	0	Recovery PEIM (Recovery started)
49h	0	1	0	0	1	0	0	1	Recovery PEIM (Capsule found)
4Ah	0	1	0	0	1	0	1	0	Recovery PEIM (Capsule loaded)
E8h	1	1	1	0	1	0	0	0	No Usable Memory Error:
E9h	1	1	1	0	1	0	0	1	Memory is locked by Intel® Trusted Execution Technology and is inaccessible.

Checkpoint	Diagnostic LED Decoder								Description
	1 = LED On, 0 = LED Off								
	Upper Nibble (Amber - Read 1 <sup>st</sup> )				Lower Nibble (Green - Read 2 <sup>nd</sup> )				
	MSB							LSB	
8h	4h	2h	1h	8h	4h	2h	1h		
EAh	1	1	1	0	1	0	1	0	DDR4 Channel Training Error:
EBh	1	1	1	0	1	0	1	1	Memory Test Failure
EDh	1	1	1	0	1	1	0	1	DIMM Configuration/Population Error
EFh	1	1	1	0	1	1	1	1	Indicates a CLTT table structure error
B0h	1	0	1	1	0	0	0	0	Detect DIMM population
B1h	1	0	1	1	0	0	0	1	Set DDR4 frequency
B2h	1	0	1	1	0	0	1	0	Gather remaining SPD data
B3h	1	0	1	1	0	0	1	1	Program registers on the memory controller level
B4h	1	0	1	1	0	1	0	0	Evaluate RAS modes and save rank information
B5h	1	0	1	1	0	1	0	1	Program registers on the channel level
B6h	1	0	1	1	0	1	1	0	Perform the JEDEC defined initialization sequence
B7h	1	0	1	1	0	1	1	1	Train DDR4 ranks
B8h	1	0	1	1	1	0	0	0	Initialize CLTT/OLTT
B9h	1	0	1	1	1	0	0	1	Hardware memory test and init
BAh	1	0	1	1	1	0	1	0	Execute software memory init
BBh	1	0	1	1	1	0	1	1	Program memory map and interleaving
BCh	1	0	1	1	1	1	0	0	Program RAS configuration
BFh	1	0	1	1	1	1	1	1	MRC is done

## Appendix E. POST Code Errors

Most error conditions encountered during POST are reported using **POST Error Codes**. These codes represent specific failures, warnings, or are informational. POST Error Codes may be displayed in the Error Manager Display screen, and are always logged to the System Event Log (SEL). Logged events are available to System Management applications, including Remote and Out of Band (OOB) management.

There are exception cases in early initialization where system resources are not adequately initialized for handling POST Error Code reporting. These cases are primarily Fatal Error conditions resulting from initialization of processors and memory, and they are handled by a Diagnostic LED display with a system halt.

The following table lists the supported POST Error Codes. Each error code is assigned an error type, which determines the action the BIOS will take when the error is encountered. Error types include Minor, Major, and Fatal. The BIOS action for each is defined as follows:

- **Minor:** The error message is displayed on the screen or on the Error Manager screen, and an error is logged to the SEL. The system continues booting in a degraded state. The user may want to replace the erroneous unit. The POST Error Pause option setting in the BIOS setup does not have any effect on this error.
- **Major:** The error message is displayed on the Error Manager screen, and an error is logged to the SEL. The POST Error Pause option setting in the BIOS setup determines whether the system pauses to the Error Manager for this type of error so the user can take immediate corrective action or the system continues booting.

Note that for 0048 “Password check failed”, the system halts, and then after the next reset/reboot will display the error code on the Error Manager screen.

- **Fatal:** The system halts during post at a blank screen with the text “Unrecoverable fatal error found. System will not boot until the error is resolved” and “Press <F2> to enter setup” The POST Error Pause option setting in the BIOS setup does not have any effect with this class of error.

When the operator presses the **F2** key on the keyboard, the error message is displayed on the Error Manager screen, and an error is logged to the SEL with the error code. The system cannot boot unless the error is resolved. The user needs to replace the faulty part and restart the system.

**Note:** The POST error codes in the following table are common to all current generation Intel server platforms. Features present on a given server board/system will determine which of the listed error codes are supported

**Table 9. POST Error Codes and Messages**

Error Code	Error Message	Action message	Response
0012	System RTC date/time not set		Major
0048	Password check failed	Put right password.	Major
0140	PCI component encountered a PERR error		Major
0141	PCI resource conflict		Major
0146	PCI out of resources error	Enable Memory Mapped I/O above 4 GB item at SETUP to use 64-bit MMIO.	Major
0191	Processor core/thread count mismatch detected	Use identical CPU type.	Fatal
0192	Processor cache size mismatch detected	Use identical CPU type.	Fatal

Intel® Server System R1000WF Product Family System Integration and Service Guide

0194	Processor family mismatch detected	Use identical CPU type.	Fatal
0195	Processor Intel(R) UPI link frequencies unable to synchronize		Fatal
0196	Processor model mismatch detected	Use identical CPU type.	Fatal
0197	Processor frequencies unable to synchronize	Use identical CPU type.	Fatal
5220	BIOS Settings reset to default settings		Major
5221	Passwords cleared by jumper		Major
5224	Password clear jumper is Set	Remind user to install BIOS password as BIOS admin password is the master keys for several BIOS security features.	Major
8130	Processor 01 disabled		Major
8131	Processor 02 disabled		Major
8160	Processor 01 unable to apply microcode update		Major
8161	Processor 02 unable to apply microcode update		Major
8170	Processor 01 failed Self Test (BIST)		Major
8171	Processor 02 failed Self Test (BIST)		Major
8180	Processor 01 microcode update not found		Minor
8181	Processor 02 microcode update not found		Minor
8190	Watchdog timer failed on last boot		Major
8198	OS boot watchdog timer failure		Major
8300	Baseboard management controller failed self test		Major
8305	Hot Swap Controller failure		Major
83A0	Management Engine (ME) failed self test		Major
83A1	Management Engine (ME) Failed to respond		Major
84F2	Baseboard management controller failed to respond		Major
84F3	Baseboard management controller in update mode		Major
84F4	Sensor data record empty	Update right SDR.	Major
8539	CPU2_DIMM_A2 failed test/initialization	Remove the disabled DIMM.	Major
853A	CPU2_DIMM_A3 failed test/initialization	Remove the disabled DIMM.	Major
853B	CPU2_DIMM_B1 failed test/initialization	Remove the disabled DIMM.	Major
853C	CPU2_DIMM_B2 failed test/initialization	Remove the disabled DIMM.	Major
853D	CPU2_DIMM_B3 failed test/initialization	Remove the disabled DIMM.	Major
853E	CPU2_DIMM_C1 failed test/initialization	Remove the disabled DIMM.	Major
853F (Go to 85C0)	CPU2_DIMM_C2 failed test/initialization	Remove the disabled DIMM.	Major
8540	CPU1_DIMM_A1 disabled	Remove the disabled DIMM.	Major
8541	CPU1_DIMM_A2 disabled	Remove the disabled DIMM.	Major
8542	CPU1_DIMM_A3 disabled	Remove the disabled DIMM.	Major
8543	CPU1_DIMM_B1 disabled	Remove the disabled DIMM.	Major
8544	CPU1_DIMM_B2 disabled	Remove the disabled DIMM.	Major

Intel® Server System R1000WF Product Family System Integration and Service Guide

8545	CPU1_DIMM_B3 disabled	Remove the disabled DIMM.	Major
8546	CPU1_DIMM_C1 disabled	Remove the disabled DIMM.	Major
8547	CPU1_DIMM_C2 disabled	Remove the disabled DIMM.	Major
8548	CPU1_DIMM_C3 disabled	Remove the disabled DIMM.	Major
8549	CPU1_DIMM_D1 disabled	Remove the disabled DIMM.	Major
854A	CPU1_DIMM_D2 disabled	Remove the disabled DIMM.	Major
854B	CPU1_DIMM_D3 disabled	Remove the disabled DIMM.	Major
854C	CPU1_DIMM_E1 disabled	Remove the disabled DIMM.	Major
854D	CPU1_DIMM_E2 disabled	Remove the disabled DIMM.	Major
854E	CPU1DIMM_E3 disabled	Remove the disabled DIMM.	Major
854F	CPU1DIMM_F1 disabled	Remove the disabled DIMM.	Major
8550	CPU1DIMM_F2 disabled	Remove the disabled DIMM.	Major
8551	CPU1DIMM_F3 disabled	Remove the disabled DIMM.	Major
8552	CPU1DIMM_G1 disabled	Remove the disabled DIMM.	Major
8553	CPU1DIMM_G2 disabled	Remove the disabled DIMM.	Major
8554	CPU1DIMM_G3 disabled	Remove the disabled DIMM.	Major
8555	CPU1DIMM_H1 disabled	Remove the disabled DIMM.	Major
8556	CPU1DIMM_H2 disabled	Remove the disabled DIMM.	Major
8557	CPU1DIMM_H3 disabled	Remove the disabled DIMM.	Major
8558	CPU2_DIMM_A1 disabled	Remove the disabled DIMM.	Major
8559	CPU2_DIMM_A2 disabled	Remove the disabled DIMM.	Major
855A	CPU2_DIMM_A3 disabled	Remove the disabled DIMM.	Major
855B	CPU2_DIMM_B1 disabled	Remove the disabled DIMM.	Major
855C	CPU2_DIMM_B2 disabled	Remove the disabled DIMM.	Major
855D	CPU2_DIMM_B3 disabled	Remove the disabled DIMM.	Major
855E	CPU2_DIMM_C1 disabled	Remove the disabled DIMM.	Major
855F (Go to 85D0)	CPU2_DIMM_C2 disabled	Remove the disabled DIMM.	Major
8560	CPU1_DIMM_A1 encountered a Serial Presence Detection (SPD) failure		Major
8561	CPU1_DIMM_A2 encountered a Serial Presence Detection (SPD) failure		Major
8562	CPU1_DIMM_A3 encountered a Serial Presence Detection (SPD) failure		Major
8563	CPU1_DIMM_B1 encountered a Serial Presence Detection (SPD) failure		Major
8564	CPU1_DIMM_B2 encountered a Serial Presence Detection (SPD) failure		Major
8565	CPU1_DIMM_B3 encountered a Serial Presence Detection (SPD) failure		Major

Intel® Server System R1000WF Product Family System Integration and Service Guide

8566	CPU1_DIMM_C1 encountered a Serial Presence Detection (SPD) failure		Major
8567	CPU1_DIMM_C2 encountered a Serial Presence Detection (SPD) failure		Major
8568	CPU1_DIMM_C3 encountered a Serial Presence Detection (SPD) failure		Major
8569	CPU1_DIMM_D1 encountered a Serial Presence Detection (SPD) failure		Major
856A	CPU1_DIMM_D2 encountered a Serial Presence Detection (SPD) failure		Major
856B	CPU1_DIMM_D3 encountered a Serial Presence Detection (SPD) failure		Major
856C	CPU1_DIMM_E1 encountered a Serial Presence Detection (SPD) failure		Major
856D	CPU1_DIMM_E2 encountered a Serial Presence Detection (SPD) failure		Major
856E	CPU1_DIMM_E3 encountered a Serial Presence Detection (SPD) failure		Major
856F	CPU1_DIMM_F1 encountered a Serial Presence Detection (SPD) failure		Major
8570	CPU1_DIMM_F2 encountered a Serial Presence Detection (SPD) failure		Major
8571	CPU1_DIMM_F3 encountered a Serial Presence Detection (SPD) failure		Major
8572	CPU1_DIMM_G1 encountered a Serial Presence Detection (SPD) failure		Major
8573	CPU1_DIMM_G2 encountered a Serial Presence Detection (SPD) failure		Major
8574	CPU1_DIMM_G3 encountered a Serial Presence Detection (SPD) failure		Major
8575	CPU1_DIMM_H1 encountered a Serial Presence Detection (SPD) failure		Major
8576	CPU1_DIMM_H2 encountered a Serial Presence Detection (SPD) failure		Major
8577	CPU1_DIMM_H3 encountered a Serial Presence Detection (SPD) failure		Major
8578	CPU2_DIMM_A1 encountered a Serial Presence Detection (SPD) failure		Major
8579	CPU2_DIMM_A2 encountered a Serial Presence Detection (SPD) failure		Major
857A	CPU2_DIMM_A3 encountered a Serial Presence Detection (SPD) failure		Major
857B	CPU2_DIMM_B1 encountered a Serial Presence Detection (SPD) failure		Major
857C	CPU2_DIMM_B2 encountered a Serial Presence Detection (SPD) failure		Major
857D	CPU2_DIMM_B3 encountered a Serial Presence Detection (SPD) failure		Major



Intel® Server System R1000WF Product Family System Integration and Service Guide

857E	CPU2_DIMM_C1 encountered a Serial Presence Detection (SPD) failure		Major
857F (Go to 85E0)	CPU2_DIMM_C2 encountered a Serial Presence Detection (SPD) failure		Major
85C0	CPU2_DIMM_C3 failed test/initialization	Remove the disabled DIMM.	Major
85C1	CPU2_DIMM_D1 failed test/initialization	Remove the disabled DIMM.	Major
85C2	CPU2_DIMM_D2 failed test/initialization	Remove the disabled DIMM.	Major
85C3	CPU2_DIMM_D3 failed test/initialization	Remove the disabled DIMM.	Major
85C4	CPU2_DIMM_E1 failed test/initialization	Remove the disabled DIMM.	Major
85C5	CPU2_DIMM_E2 failed test/initialization	Remove the disabled DIMM.	Major
85C6	CPU2_DIMM_E3 failed test/initialization	Remove the disabled DIMM.	Major
85C7	CPU2_DIMM_F1 failed test/initialization	Remove the disabled DIMM.	Major
85C8	CPU2_DIMM_F2 failed test/initialization	Remove the disabled DIMM.	Major
85C9	CPU2_DIMM_F3 failed test/initialization	Remove the disabled DIMM.	Major
85CA	CPU2_DIMM_G1 failed test/initialization	Remove the disabled DIMM.	Major
85CB	CPU2_DIMM_G2 failed test/initialization	Remove the disabled DIMM.	Major
85CC	CPU2_DIMM_G3 failed test/initialization	Remove the disabled DIMM.	Major
85CD	CPU2_DIMM_H1 failed test/initialization	Remove the disabled DIMM.	Major
85CE	CPU2_DIMM_H2 failed test/initialization	Remove the disabled DIMM.	Major
85CF	CPU2_DIMM_H3 failed test/initialization	Remove the disabled DIMM.	Major
85D0	CPU2_DIMM_C3 disabled	Remove the disabled DIMM.	Major
85D1	CPU2_DIMM_D1 disabled	Remove the disabled DIMM.	Major
85D2	CPU2_DIMM_D2 disabled	Remove the disabled DIMM.	Major
85D3	CPU2_DIMM_D3 disabled	Remove the disabled DIMM.	Major
85D4	CPU2_DIMM_E1 disabled	Remove the disabled DIMM.	Major
85D5	CPU2_DIMM_E2 disabled	Remove the disabled DIMM.	Major
85D6	CPU2_DIMM_E3 disabled	Remove the disabled DIMM.	Major
85D7	CPU2_DIMM_F1 disabled	Remove the disabled DIMM.	Major
85D8	CPU2_DIMM_F2 disabled	Remove the disabled DIMM.	Major
85D9	CPU2_DIMM_F3 disabled	Remove the disabled DIMM.	Major
85DA	CPU2_DIMM_G1 disabled	Remove the disabled DIMM.	Major
85DB	CPU2_DIMM_G2 disabled	Remove the disabled DIMM.	Major
85DC	CPU2_DIMM_G3 disabled	Remove the disabled DIMM.	Major
85DD	CPU2_DIMM_H1 disabled	Remove the disabled DIMM.	Major
85DE	CPU2_DIMM_H2 disabled	Remove the disabled DIMM.	Major
85DF	CPU2_DIMM_H3 disabled	Remove the disabled DIMM.	Major
85E0	CPU2_DIMM_C3 encountered a Serial Presence Detection (SPD) failure		Major
85E1	CPU2_DIMM_D1 encountered a Serial Presence Detection (SPD) failure		Major

Intel® Server System R1000WF Product Family System Integration and Service Guide

85E2	CPU2_DIMM_D2 encountered a Serial Presence Detection (SPD) failure		Major
85E3	CPU2_DIMM_D3 encountered a Serial Presence Detection (SPD) failure		Major
85E4	CPU2_DIMM_E1 encountered a Serial Presence Detection (SPD) failure		Major
85E5	CPU2_DIMM_E2 encountered a Serial Presence Detection (SPD) failure		Major
85E6	CPU2_DIMM_E3 encountered a Serial Presence Detection (SPD) failure		Major
85E7	CPU2_DIMM_F1 encountered a Serial Presence Detection (SPD) failure		Major
85E8	CPU2_DIMM_F2 encountered a Serial Presence Detection (SPD) failure		Major
85E9	CPU2_DIMM_F3 encountered a Serial Presence Detection (SPD) failure		Major
85EA	CPU2_DIMM_G1 encountered a Serial Presence Detection (SPD) failure		Major
85EB	CPU2_DIMM_G2 encountered a Serial Presence Detection (SPD) failure		Major
85EC	CPU2_DIMM_G3 encountered a Serial Presence Detection (SPD) failure		Major
85ED	CPU2_DIMM_H1 encountered a Serial Presence Detection (SPD) failure		Major
85EE	CPU2_DIMM_H2 encountered a Serial Presence Detection (SPD) failure		Major
85EF	CPU2_DIMM_H3 encountered a Serial Presence Detection (SPD) failure		Major
8604	POST Reclaim of non-critical NVRAM variables		Minor
8605	BIOS Settings are corrupted		Major
8606	NVRAM variable space was corrupted and has been reinitialized		Major
8607	Recovery boot has been initiated. <b>Note:</b> The Primary BIOS image may be corrupted or the system may hang during POST. A BIOS update is required.		Fatal
92A3	Serial port component was not detected		Major
92A9	Serial port component encountered a resource conflict error		Major
A000	TPM device not detected		Minor
A001	TPM device missing or not responding		Minor
A002	TPM device failure		Minor
A003	TPM device failed self test		Minor
A100	BIOS ACM Error		Major
A421	PCI component encountered a SERR error		Fatal
A5A0	PCI Express component encountered a PERR error		Minor

A5A1	PCI Express component encountered an SERR error		Fatal
A6A0	DXE Boot Services driver: Not enough memory available to shadow a Legacy Option ROM	Disable oprom at SETUP to save runtime memory.	Minor

## POST Error Beep Codes

The following table lists the POST error beep codes. Prior to system video initialization, the BIOS uses these beep codes to inform users on error conditions. The beep code is followed by a user-visible code on the POST Progress LEDs.

**Table 10. POST Error Beep Codes**

Beeps	Error Message	POST Progress Code	Description
1	USB device action	N/A	Short beep sounded whenever USB device is discovered in POST, or inserted or removed during runtime.
1 long	Intel® TXT security violation	0xAE, 0xAF	System halted because Intel® Trusted Execution Technology detected a potential violation of system security.
3	Memory error	Multiple	System halted because a fatal error related to the memory was detected.
3 long and 1	CPU mismatch error	0xE5, 0xE6	System halted because a fatal error related to the CPU family/core/cache mismatch was detected.
The following Beep Codes are sounded during BIOS Recovery.			
2	Recovery started	N/A	Recovery boot has been initiated.
4	Recovery failed	N/A	Recovery has failed. This typically happens so quickly after recovery is initiated that it sounds like a 2–4 beep code.

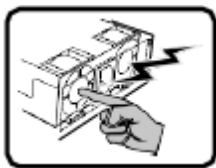
The Integrated BMC may generate beep codes upon detection of failure conditions. Beep codes are sounded each time the problem is discovered, such as on each power-up attempt, but are not sounded continuously. Codes that are common across all Intel® Server Boards and systems that use same generation chipset are listed in the following table. Each digit in the code is represented by a sequence of beeps whose count is equal to the digit.

**Table 11. Integrated BMC Beep Codes**

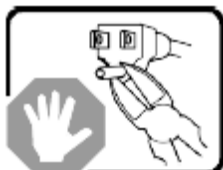
<b>Code</b>	<b>Reason for Beep</b>	<b>Associated Sensors</b>
1-5-1-2	VR Watchdog Timer sensor assertion	VR Watchdog Timer
1-5-1-4	The system does not power on or unexpectedly power off and a power supply unit (PSU) is present that is an incompatible model with one or more other PSUs in the system	PS Status
1-5-2-1	No CPUs installed or first CPU socket is empty	CPU Missing Sensor
1-5-2-2	CPU CAT Error (IERR) assertion	CPU ERR2 Timeout Sensor
1-5-2-3	CPU ERR2 timeout assertion	CPU ERR2 Timeout Sensor
1-5-2-4	CPU lcc max Mismatch	CPU lcc max Mismatch Sensor
1-5-2-5	CPU population error	CPU 0 Status Sensor
1-5-4-2	Power fault: DC power is unexpectedly lost (power good dropout).	Power unit – power unit failure offset
1-5-4-4	Power control fault (power good assertion timeout).	Power unit – soft power control failure offset

## Appendix F. Safety Instructions

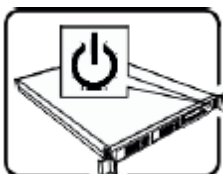
### WARNING: English (US)



The power supply in this product contains no user-serviceable parts. There may be more than one supply in this product. Refer servicing only to qualified personnel.



Do not attempt to modify or use the supplied AC power cord if it is not the exact type required. A product with more than one power supply will have a separate AC power cord for each supply.



The power button on the system does not turn off system AC power. To remove AC power from the system, you must unplug each AC power cord from the wall outlet or power supply.

The power cord(s) is considered the disconnect device to the main (AC) power. The socket outlet that the system plugs into shall be installed near the equipment and shall be easily accessible.



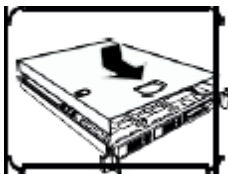
**SAFETY STEPS:** Whenever you remove the chassis covers to access the inside of the system, follow these steps:

1. Turn off all peripheral devices connected to the system.
2. Turn off the system by pressing the power button.
3. Unplug all AC power cords from the system or from wall outlets.
4. Label and disconnect all cables connected to I/O connectors or ports on the back of the system.
5. Provide some electrostatic discharge (ESD) protection by wearing an antistatic wrist strap attached to chassis ground of the system—any unpainted metal surface—when handling components.
6. Do not operate the system with the chassis covers removed.



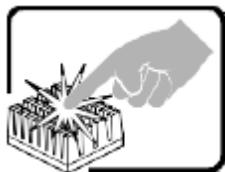
After you have completed the six SAFETY steps above, you can remove the system top covers. To do this:

1. Unlock and remove the padlock from the back of the system if a padlock has been installed.
2. Remove and save all screws from the covers.
3. Remove the covers.



For proper cooling and airflow, always reinstall the chassis covers before turning on the system. Operating the system without the covers in place can damage system parts. To install the covers:

1. Check first to make sure you have not left loose tools or parts inside the system.
2. Check that cables, add-in boards, and other components are properly installed.
3. Attach the covers to the chassis with the screws removed earlier, and tighten them firmly.
4. Insert and lock the padlock to the system to prevent unauthorized access inside the system.
5. Connect all external cables and the AC power cord(s) to the system.



A microprocessor and heat sink may be hot if the system has been running. Also, there may be sharp pins and edges on some board and chassis parts. Contact should be made with care. Consider wearing protective gloves.



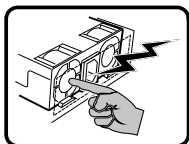
Danger of explosion if the battery is incorrectly replaced. Replace only with the same or equivalent type recommended by the equipment manufacturer. Dispose of used batteries according to manufacturer's instructions.



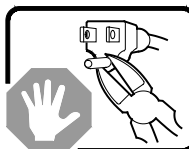
The system is designed to operate in a typical office environment. Choose a site that is:

- Clean and free of airborne particles (other than normal room dust).
- Well ventilated and away from sources of heat including direct sunlight.
- Away from sources of vibration or physical shock.
- Isolated from strong electromagnetic fields produced by electrical devices.
- In regions that are susceptible to electrical storms, we recommend you plug your system into a surge suppresser and disconnect telecommunication lines to your modem during an electrical storm.
- Provided with a properly grounded wall outlet.
- Provided with sufficient space to access the power supply cord(s), because they serve as the product's main power disconnect.

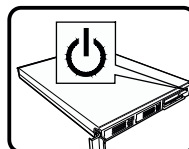
## ОСТОРОЖНО: русский



Блок питания данного изделия не содержит деталей, подлежащих обслуживанию пользователем. В этом изделии может быть несколько блоков питания. Обслуживание должно выполняться только квалифицированным персоналом.

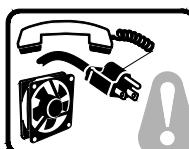


Не модифицируйте и не используйте прилагаемый кабель питания, если он не соответствует требуемому типу. Если в устройстве несколько блоков питания, то к каждому блоку питания прилагается отдельный кабель питания.



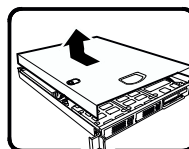
При нажатии кнопки питания не отключается питание системы от электросети. Чтобы отключить подачу питания переменного тока в систему, необходимо отсоединить все кабели питания от электрической розетки или блока питания.

Кабель питания считается размыкателем питания переменного тока. Электрическая розетка, к которой подключается система, должна находиться рядом с оборудованием и быть легко доступной.



**ИНСТРУКЦИИ ПО ТЕХНИКЕ БЕЗОПАСНОСТИ.** Каждый раз перед снятием крышек корпуса для доступа к внутренней части системы выполняйте следующие действия:

1. Выключите все периферийные устройства, подключенные к системе.
2. Выключите систему, нажав кнопку питания.
3. Отсоедините все кабели питания от системы или электрических розеток.
4. Промаркируйте и отсоедините все кабели, подключенные к разъемам или портам ввода/вывода на задней панели системы.
5. Для обеспечения защиты от электростатического разряда при работе с компонентами надевайте антистатический браслет, прикрепленный к заземленной части корпуса системы (любой неокрашенной металлической поверхности).
6. Запрещается работать с системой, когда крышки корпуса сняты.

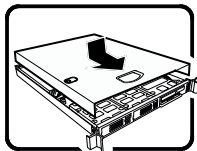


Крышки корпуса системы можно снимать, когда выполнены все шесть описанных выше мер безопасности. Для этого:

1. Откройте и снимите навесной замок (если имеется) с задней части системы.
2. Выверните все винты с крышек и сохраните их.
3. Снимите крышки.

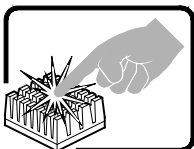
(продолжение)

**ОСТОРОЖНО: русский** (продолжение)

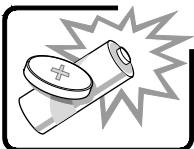


Для обеспечения надлежащего охлаждения и воздушного потока всегда устанавливайте на место крышки корпуса перед включением системы. Работа системы без установленных крышек может привести к повреждению компонентов системы. Чтобы установить крышки, выполните следующие действия:

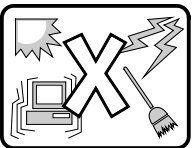
1. Сначала проверьте, не осталось ли в системе незакрепленных инструментов или деталей.
2. Убедитесь, что кабели, платы расширения и другие компоненты установлены правильно.
3. Закрепите крышки на корпусе, завернув и надежно затянув винты, снятые ранее.
4. Установите и закройте навесной замок для предотвращения несанкционированного доступа внутрь системы.
5. Подключите к системе все внешние кабели и кабели питания.



Микропроцессор и теплоотвод могут нагреваться во время работы системы. На некоторых деталях платы и корпуса могут быть острые выступы и кромки. Соблюдайте осторожность. Рекомендуется использовать защитные перчатки.



В случае неправильной замены аккумулятора существует опасность взрыва. При замене используйте только те же или эквивалентные модели аккумуляторов, рекомендованные производителем оборудования. Утилизируйте использованные аккумуляторы в соответствии с инструкциями производителя.

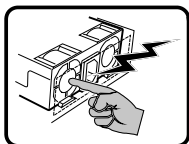


Система предназначена для работы в обычной офисной среде. Место установки системы должно соответствовать следующим требованиям:

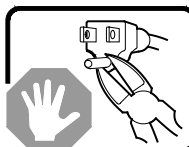
- Помещение должно быть чистым, в воздухе не должно быть взвешенных частиц (кроме обычной пыли).
- Место установки должно хорошо вентилироваться и находиться вдали от источников тепла (включая прямой солнечный свет).
- Место установки должно находиться вдали от источников вибрации или механических ударов.
- Место установки должно быть изолировано от сильных электромагнитных полей, создаваемых электрическими устройствами.
- В регионах, где часто бывает гроза, рекомендуется подключать систему к сетевому фильтру и отключать телекоммуникационные линии от модема во время грозы.
- В помещении должна быть правильно заземленная электрическая розетка.
- Должен быть оставлен достаточный зазор для доступа к кабелям питания, которые служат размыкателем электропитания системы.



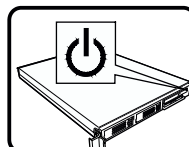
## УВАГА! Українська



Джерело живлення в цьому виробі не містить жодних частин, які користувачі могли б обслуговувати самостійно. Цей виріб може містити більше одного джерела живлення. Обслуговувати його може виключно кваліфікований персонал.

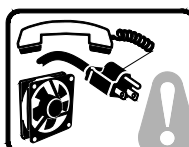


Не намагайтеся модифікувати шнур живлення змінного струму з комплекту або користуватися ним, якщо він не відповідає потрібному типу. Виріб із джерелами живлення більше одного має окремі шнури живлення змінного струму для кожного джерела.



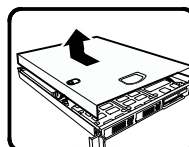
Кнопка живлення на системі не вимикає живлення змінного струму системи. Щоб позбавити систему змінного струму, слід вийняти всі шнури живлення змінного струму зі стінних розеток або джерел живлення.

Вважається, що шнур(и) живлення є пристроями вимкнення основного живлення (змінного струму). Розетка електромережі, до якої підключається система, мусить бути розташована поруч із обладнанням і легкодоступна.



**КРОКИ БЕЗПЕКИ:** Щоразу, знімаючи корпус для доступу до внутрішніх частин системи, виконуйте ці кроки:

1. Вимкніть усі периферійні пристрої, підключені до системи.
2. Вимкніть систему, натиснувши кнопку живлення.
3. Вийміть шнури живлення змінного струму із системи чи стінних розеток.
4. Позначте і від'єднайте всі кабелі, підключені до з'єднувачів входу/виходу або портів ззаду на системі.
5. Працюючи з компонентами, захищайтеся від електростатичних розрядів (ЕР), вдягаючи антистатичний ремінець-браслет, прикріплений до елемента заземлення корпусу - будь-якої непофарбованої металевої поверхні.
6. Не використовуйте систему з відкритим корпусом.



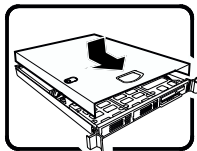
Після виконання шести наведених вище кроків БЕЗПЕКИ можна знімати корпус (кришки) з системи.

Для цього виконайте такі дії:

1. Розблокуйте і зніміть замок ззаду на системі, якщо його встановлено.
2. Зніміть і збережіть всі гвинти з кришок.
3. Зніміть усі кришки.

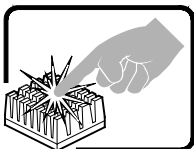
продовження

## УВАГА! Українська (продовження)

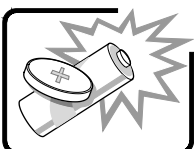


Для правильного охолодження та вентиляції завжди повертайте на місце кришки корпусу перед увімкненням системи. Робота системи без кришок може пошкодити деталі системи. Щоб установити кришки, виконайте такі дії:

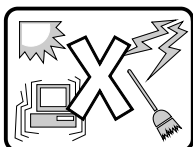
1. Спочатку переконайтеся, що всередині системи не залишилося деталей або незакріплених інструментів.
2. Перевірте, чи правильно встановлено кабелі, розширювальні плати та інші компоненти.
3. Прикріпіть кришки до корпусу знятими раніше гвинтами та надійно їх затягніть.
4. Вставте в систему і зафіксуйте замок, щоб запобігти неавторизованому доступу до нього.
5. Підключіть усі зовнішні кабелі та шнур(и) живлення змінного струму до системи.



Під час роботи системи мікропроцесор і радіатор можуть розігрітися до гарячого. Деякі частини корпусу і плат можуть мати гострі шипи або краї. Із ними слід поводитися обережно. Можна вдягти захисні рукавички.



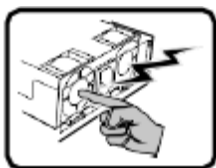
Загроза вибуху, якщо батарею замінено на неправильну. Замінійте лише таким самим або еквівалентним типом, рекомендованим виробником. Утилізуйте використані батареї згідно з інструкціями виробника.



Систему створено для роботи в типовому офісному приміщенні. Виберіть місце, яке:

- Чисте і де немає в повітрі інших дрібних часточок, окрім звичайного побутового пилу.
- Добре провітрюється, розташоване далеко від джерел тепла, включно з прямим сонячним промінням.
- Розташоване далеко від джерел вібрації і струсів.
- Ізольоване від сильних електромагнітних полів, спричинених електроприладами.
- У регіонах, де часто проходять грози, радимо підключати пристрій через пристрій захисту від викидів напруги та відключити телекомунікаційні лінії від модему під час грози.
- Оснащене правильно заземленими стінними розетками електромережі.
- Має достатньо простору для доступу до шнура(ів) живлення, оскільки вони слугують основними вимикачами виробу.

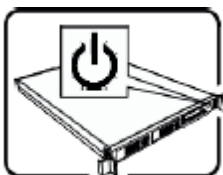
## AVERTISSEMENT: Français



Le bloc d'alimentation de ce produit ne contient aucune pièce pouvant être réparée par l'utilisateur. Ce produit peut contenir plus d'un bloc d'alimentation. Veuillez contacter un technicien qualifié en cas de problème.



Ne pas essayer d'utiliser ni modifier le câble d'alimentation CA fourni, s'il ne correspond pas exactement au type requis. Le nombre de câbles d'alimentation CA fournis correspond au nombre de blocs d'alimentation du produit.

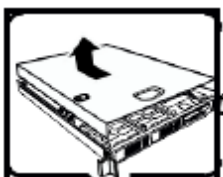


Notez que le commutateur CC de mise sous tension /hors tension du panneau avant n'éteint pas l'alimentation CA du système. Pour mettre le système hors tension, vous devez débrancher chaque câble d'alimentation de sa prise.



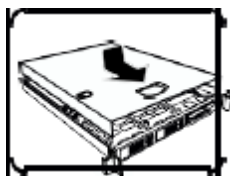
**CONSIGNES DE SÉCURITÉ:** Lorsque vous ouvrez le boîtier pour accéder à l'intérieur du système, suivez les consignes suivantes:

1. Mettez hors tension tous les périphériques connectés au système.
2. Mettez le système hors tension en mettant l'interrupteur général en position OFF (bouton-poussoir).
3. Débranchez tous les cordons d'alimentation c.a. du système et des prises murales.
4. Identifiez et débranchez tous les câbles reliés aux connecteurs d'E-S ou aux accès derrière le système.
5. Pour prévenir les décharges électrostatiques lorsque vous touchez aux composants, portez une bande antistatique pour poignet et reliez-la à la masse du système (toute surface métallique non peinte du boîtier).
6. Ne faites pas fonctionner le système tandis que le boîtier est ouvert.



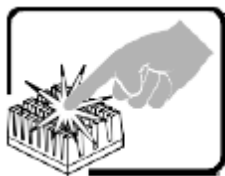
Une fois TOUTES les étapes précédentes accomplies, vous pouvez retirer les panneaux du système. Procédez comme suit:

1. Si un cadenas a été installé sur à l'arrière du système, déverrouillez-le et retirez-le.
2. Retirez toutes les vis des panneaux et mettez-les dans un endroit sûr.
3. Retirez les panneaux.



Afin de permettre le refroidissement et l'aération du système, réinstallez toujours les panneaux du boîtier avant de mettre le système sous tension. Le fonctionnement du système en l'absence des panneaux risque d'endommager ses pièces. Pour installer les panneaux, procédez comme suit:

1. Assurez-vous de ne pas avoir oublié d'outils ou de pièces démontées dans le système.
2. Assurez-vous que les câbles, les cartes d'extension et les autres composants sont bien installés.
3. Revissez solidement les panneaux du boîtier avec les vis retirées plus tôt.
4. Remettez le cadenas en place et verrouillez-le afin de prévenir tout accès non autorisé à l'intérieur du système.
5. Rebranchez tous les cordons d'alimentation c. a. et câbles externes au système.



Le microprocesseur et le dissipateur de chaleur peuvent être chauds si le système a été sous tension. Faites également attention aux broches aiguës des cartes et aux bords tranchants du capot. Nous vous recommandons l'usage de gants de protection.



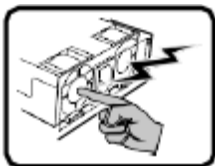
Danger d'explosion si la batterie n'est pas remontée correctement. Remplacer uniquement avec une batterie du même type ou d'un type équivalent recommandé par le fabricant. Disposez des piles usées selon les instructions du fabricant.



Le système a été conçu pour fonctionner dans un cadre de travail normal. L'emplacement choisi doit être:

- Propre et dépourvu de poussière en suspension (sauf la poussière normale).
- Bien aéré et loin des sources de chaleur, y compris du soleil direct.
- A l'abri des chocs et des sources de vibrations.
- Isolé de forts champs électromagnétiques générés par des appareils électriques.
- Dans les régions sujettes aux orages magnétiques il est recommandé de brancher votre système à un suppresseur de surtension, et de débrancher toutes les lignes de télécommunications de votre modem durant un orage.
- Muni d'une prise murale correctement mise à la terre.
- Suffisamment spacieux pour vous permettre d'accéder aux câbles d'alimentation (ceux-ci étant le seul moyen de mettre le système hors tension).

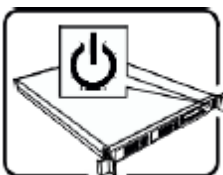
## WARNUNG: Deutsch



Benutzer können am Netzgerät dieses Produkts keine Reparaturen vornehmen. Das Produkt enthält möglicherweise mehrere Netzgeräte. Wartungsarbeiten müssen von qualifizierten Technikern ausgeführt werden.



Versuchen Sie nicht, das mitgelieferte Netzkabel zu ändern oder zu verwenden, wenn es sich nicht genau um den erforderlichen Typ handelt. Ein Produkt mit mehreren Netzgeräten hat für jedes Netzgerät ein eigenes Netzkabel.

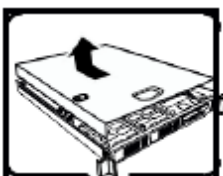


Der Wechselstrom des Systems wird durch den Ein-/Aus-Schalter für Gleichstrom nicht ausgeschaltet. Ziehen Sie jedes Wechselstrom-Netzkabel aus der Steckdose bzw. dem Netzgerät, um den Stromanschluß des Systems zu unterbrechen.



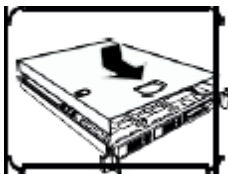
**SICHERHEISSMASSNAHMEN:** Immer wenn Sie die Gehäuseabdeckung abnehmen um an das Systeminnere zu gelangen, sollten Sie folgende Schritte beachten:

1. Schalten Sie alle an Ihr System angeschlossenen Peripheriegeräte aus.
2. Schalten Sie das System mit dem Hauptschalter aus.
3. Ziehen Sie den Stromanschlußstecker Ihres Systems aus der Steckdose.
4. Auf der Rückseite des Systems beschrifteten und ziehen Sie alle Anschlußkabel von den I/O Anschlüssen oder Ports ab.
5. Tragen Sie ein geerdetes Antistatik Gelenkband, um elektrostatische Ladungen (ESD) über blanke Metallstellen bei der Handhabung der Komponenten zu vermeiden.
6. Schalten Sie das System niemals ohne ordnungsgemäß montiertes Gehäuse ein.



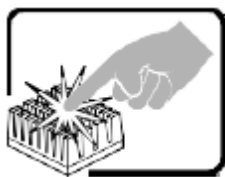
Nachdem Sie die oben erwähnten ersten sechs SICHERHEITSSCHRITTE durchgeführt haben, können Sie die Abdeckung abnehmen, indem Sie:

1. Öffnen und entfernen Sie die Verschlusseinrichtung (Padlock) auf der Rückseite des Systems, falls eine Verschlusseinrichtung installiert ist.
2. Entfernen Sie alle Schrauben der Gehäuseabdeckung.
3. Nehmen Sie die Abdeckung ab.



Zur ordnungsgemäßen Kühlung und Lüftung muß die Gehäuseabdeckung immer wieder vor dem Einschalten installiert werden. Ein Betrieb des Systems ohne angebrachte Abdeckung kann Ihrem System oder Teile darin beschädigen. Um die Abdeckung wieder anzubringen:

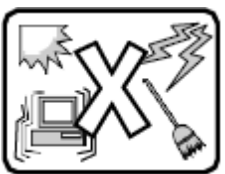
1. Vergewissern Sie sich, daß Sie keine Werkzeuge oder Teile im Innern des Systems zurückgelassen haben.
2. Überprüfen Sie alle Kabel, Zusatzkarten und andere Komponenten auf ordnungsgemäßen Sitz und Installation.
3. Bringen Sie die Abdeckungen wieder am Gehäuse an, indem Sie die zuvor gelösten Schrauben wieder anbringen. Ziehen Sie diese gut an.
4. Bringen Sie die Verschlusseinrichtung (Padlock) wieder an und schließen Sie diese, um ein unerlaubtes Öffnen des Systems zu verhindern.
5. Schließen Sie alle externen Kabel und den AC Stromanschlußstecker Ihres Systems wieder an.



Der Mikroprozessor und der Kühler sind möglicherweise erhitzt, wenn das System in Betrieb ist. Außerdem können einige Platinen und Gehäuseteile scharfe Spitzen und Kanten aufweisen. Arbeiten an Platinen und Gehäuse sollten vorsichtig ausgeführt werden. Sie sollten Schutzhandschuhe tragen.



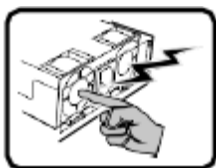
Bei falschem Einsetzen einer neuen Batterie besteht Explosionsgefahr. Die Batterie darf nur durch denselben oder einen entsprechenden, vom Hersteller empfohlenen Batterietyp ersetzt werden. Entsorgen Sie verbrauchte Batterien den Anweisungen des Herstellers entsprechend.



Das System wurde für den Betrieb in einer normalen Büroumgebung entwickelt. Der Standort sollte:

- sauber und staubfrei sein (Hausstaub ausgenommen);
- gut gelüftet und keinen Heizquellen ausgesetzt sein (einschließlich direkter Sonneneinstrahlung);
- keinen Erschütterungen ausgesetzt sein;
- keine starken, von elektrischen Geräten erzeugten elektromagnetischen Felder aufweisen;
- in Regionen, in denen elektrische Stürme auftreten, mit einem Überspannungsschutzgerät verbunden sein; während eines elektrischen Sturms sollte keine Verbindung der Telekommunikationsleitungen mit dem Modem bestehen;
- mit einer geerdeten Wechselstromsteckdose ausgerüstet sein;
- über ausreichend Platz verfügen, um Zugang zu den Netzkabeln zu gewährleisten, da der Stromanschluß des Produkts hauptsächlich über die Kabel unterbrochen wird.

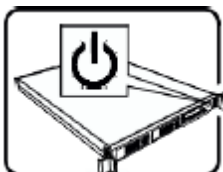
## AVVERTENZA: Italiano



Rivolgersi ad un tecnico specializzato per la riparazione dei componenti dell'alimentazione di questo prodotto. È possibile che il prodotto disponga di più fonti di alimentazione.



Non modificare o utilizzare il cavo di alimentazione in c.a. fornito dal produttore, se non corrisponde esattamente al tipo richiesto. Ad ogni fonte di alimentazione corrisponde un cavo di alimentazione in c.a. separato.

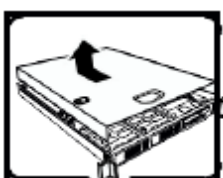


L'interruttore attivato/disattivato nel pannello anteriore non interrompe l'alimentazione in c.a. del sistema. Per interromperla, è necessario scollegare tutti i cavi di alimentazione in c.a. dalle prese a muro o dall'alimentazione di corrente.



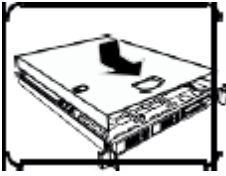
**PASSI DI SICUREZZA:** Qualora si rimuovano le coperture del telaio per accedere all'interno del sistema, seguire i seguenti passi:

1. Spegnerne tutti i dispositivi periferici collegati al sistema.
2. Spegnerne il sistema, usando il pulsante spento/acceso dell'interruttore del sistema.
3. Togliere tutte le spine dei cavi del sistema dalle prese elettriche.
4. Identificare e sconnettere tutti i cavi attaccati ai collegamenti I/O od alle prese installate sul retro del sistema.
5. Qualora si tocchino i componenti, proteggersi dallo scarico elettrostatico (SES), portando un cinghia anti-statica da polso che è attaccata alla presa a terra del telaio del sistema – qualsiasi superficie non dipinta – .
6. Non far operare il sistema quando il telaio è senza le coperture.



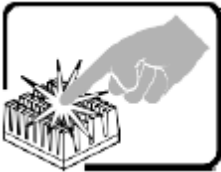
Dopo aver seguito i sei passi di SICUREZZA sopracitati, togliere le coperture del telaio del sistema come segue:

1. Aprire e rimuovere il lucchetto dal retro del sistema qualora ve ne fosse uno installato.
2. Togliere e mettere in un posto sicuro tutte le viti delle coperture.
3. Togliere le coperture.



Per il giusto flusso dell'aria e raffreddamento del sistema, rimettere sempre le coperture del telaio prima di riaccendere il sistema. Operare il sistema senza le coperture al loro proprio posto potrebbe danneggiare i componenti del sistema. Per rimettere le coperture del telaio:

1. Controllare prima che non si siano lasciati degli attrezzi o dei componenti dentro il sistema.
2. Controllare che i cavi, dei supporti aggiuntivi ed altri componenti siano stati installati appropriatamente.
3. Attaccare le coperture al telaio con le viti tolte in precedenza e avvitarle strettamente.
4. Inserire e chiudere a chiave il lucchetto sul retro del sistema per impedire l'accesso non autorizzato al sistema.
5. Ricollegare tutti i cavi esterni e le prolunghe AC del sistema.



Se il sistema è stato a lungo in funzione, il microprocessore e il dissipatore di calore potrebbero essere surriscaldati. Fare attenzione alla presenza di piedini appuntiti e parti taglienti sulle schede e sul telaio. È consigliabile l'uso di guanti di protezione.



Esiste il pericolo di un esplosione se la pila non viene sostituita in modo corretto. Utilizzare solo pile uguali o di tipo equivalente a quelle consigliate dal produttore. Per disfarsi delle pile usate, seguire le istruzioni del produttore.

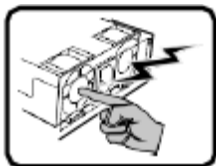


Il sistema è progettato per funzionare in un ambiente di lavoro tipo. Scegliere una postazione che sia:

- Pulita e libera da particelle in sospensione (a parte la normale polvere presente nell'ambiente).
- Ben ventilata e lontana da fonti di calore, compresa la luce solare diretta.
- Al riparo da urti e lontana da fonti di vibrazione.
- Isolata dai forti campi magnetici prodotti da dispositivi elettrici.
- In aree soggette a temporali, è consigliabile collegare il sistema ad un limitatore di corrente. In caso di temporali, scollegare le linee di comunicazione dal modem.
- Dotata di una presa a muro correttamente installata.
- Dotata di spazio sufficiente ad accedere ai cavi di alimentazione, i quali rappresentano il mezzo principale di scollegamento del sistema.



## ADVERTENCIAS: Español

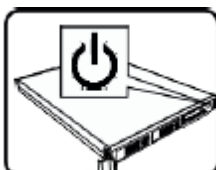


El usuario debe abstenerse de manipular los componentes de la fuente de alimentación de este producto, cuya reparación debe dejarse exclusivamente en manos de personal técnico especializado. Puede que este producto disponga de más de una fuente de alimentación.



No intente modificar ni usar el cable de alimentación de corriente alterna, si no corresponde exactamente con el tipo requerido.

El número de cables suministrados se corresponden con el número de fuentes de alimentación de corriente alterna que tenga el producto.

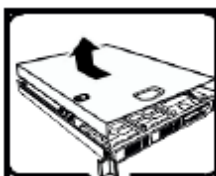


Nótese que el interruptor activado/desactivado en el panel frontal no desconecta la corriente alterna del sistema. Para desconectarla, deberá desenchufar todos los cables de corriente alterna de la pared o desconectar la fuente de alimentación.



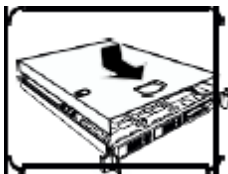
**INSTRUCCIONES DE SEGURIDAD:** Cuando extraiga la tapa del chasis para acceder al interior del sistema, siga las siguientes instrucciones:

1. Apague todos los dispositivos periféricos conectados al sistema.
2. Apague el sistema presionando el interruptor encendido/apagado.
3. Desconecte todos los cables de alimentación CA del sistema o de las tomas de corriente alterna.
4. Identifique y desconecte todos los cables enchufados a los conectores E/S o a los puertos situados en la parte posterior del sistema.
5. Cuando manipule los componentes, es importante protegerse contra la descarga electrostática (ESD). Puede hacerlo si utiliza una muñequera antiestática sujeta a la toma de tierra del chasis — o a cualquier tipo de superficie de metal sin pintar.
6. No ponga en marcha el sistema si se han extraído las tapas del chasis.



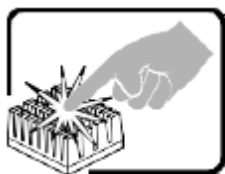
Después de completar las seis instrucciones de SEGURIDAD mencionadas, ya puede extraer las tapas del sistema. Para ello:

1. Desbloquee y extraiga el bloqueo de seguridad de la parte posterior del sistema, si se ha instalado uno.
2. Extraiga y guarde todos los tornillos de las tapas.
3. Extraiga las tapas.



Para obtener un enfriamiento y un flujo de aire adecuados, reinstale siempre las tapas del chasis antes de poner en marcha el sistema. Si pone en funcionamiento el sistema sin las tapas bien colocadas puede dañar los componentes del sistema. Para instalar las tapas:

1. Asegúrese primero de no haber dejado herramientas o componentes sueltos dentro del sistema.
2. Compruebe que los cables, las placas adicionales y otros componentes se hayan instalado correctamente.
3. Incorpore las tapas al chasis mediante los tornillos extraídos anteriormente, tensándolos firmemente.
4. Inserte el bloqueo de seguridad en el sistema y bloquéelo para impedir que pueda accederse al mismo sin autorización.
5. Conecte todos los cables externos y los cables de alimentación CA al sistema.



Si el sistema ha estado en funcionamiento, el microprocesador y el disipador de calor pueden estar aún calientes. También conviene tener en cuenta que en el chasis o en el tablero puede haber piezas cortantes o punzantes. Por ello, se recomienda precaución y el uso de guantes protectores.



Existe peligro de explosión si la pila no se cambia de forma adecuada. Utilice solamente pilas iguales o del mismo tipo que las recomendadas por el fabricante del equipo. Para deshacerse de las pilas usadas, siga igualmente las instrucciones del fabricante.

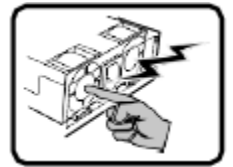


El sistema está diseñado para funcionar en un entorno de trabajo normal. Escoja un lugar:

- Limpio y libre de partículas en suspensión (salvo el polvo normal).
- Bien ventilado y alejado de fuentes de calor, incluida la luz solar directa.
- Alejado de fuentes de vibración.
- Aislado de campos electromagnéticos fuertes producidos por dispositivos eléctricos.
- En regiones con frecuentes tormentas eléctricas, se recomienda conectar su sistema a un eliminador de sobrevoltaje y desconectar el módem de las líneas de telecomunicación durante las tormentas.
- Provisto de una toma de tierra correctamente instalada.
- Provisto de espacio suficiente como para acceder a los cables de alimentación, ya que éstos hacen de medio principal de desconexión del sistema.

**אזהרה: עברית**

אספקת החשמל במוצר זה לא מכילה חלקים שניתנים לשירות על ידי משתמש. ייתכן שיש יותר ממקור אספקת חשמל אחד במוצר זה. לקבלת שירות יש לפנות רק אל אנשים המוסמכים לכך.

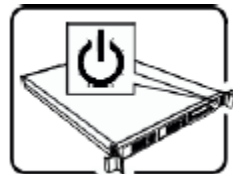


אין לנסות לשנות את כבל החשמל ז"ח המסופק, או לשנותו, אם הוא לא מהסוג המדויק הנדרש. למוצר עם יותר ממקור אספקת חשמל אחד יצורף כבל חשמל נפרד לכל מקור אספקת חשמל.



מתג ההפעלה במערכת לא מכבה את מערכת חשמל ז"ח. להסרת חשמל ז"ח מהמערכת, יש לנתק כל כבל חשמל ז"ח משקע הקיר או מאספקת החשמל.

מכבלי (י) החשמל נחשבים (ים) להתקן (ני) ניתוק מקור אספקת חשמל ז"ח. שקע הקיר שאליו מחוברת המערכת יותקן בסמוך לציוד ויהיה נגיש בקלות.



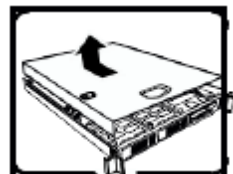
שלבי בטיחות: בכל פעם שמסירים את מכסי המעטפת כדי לגשת לחלק הפנימי של המערכת, יש לבצע את הצעדים הבאים:

1. לכבות את כל ההתקנים ההיקפיים שמחוברים למערכת.
2. לכבות את המערכת על ידי לחיצה על מתג ההפעלה.
3. לנתק את כל כבלי חשמל ז"ח מהמערכת או משקעי הקיר.
4. לתייג את כל הכבלים המחוברים למחברי קלט/פלט או ליציאות בגב המערכת ולנתק אותם.
5. לספק הגנה מסוימת מפריקות אלקטרוסטטיות (ESD) על ידי חבישת רצועת שורש כף יד אנטיסטטית שמחוברת להארקת המעטפת של המערכת - כל משטח מתכת לא צבוע - בעת הטיפול ברכיבים.
6. אין להפעיל את המערכת כשמכסי המעטפת מוסרים.

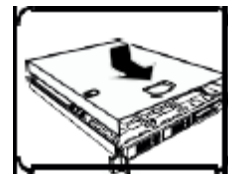


לאחר השלמת ששת שלבי הבטיחות לעיל, באפשרותכם להסיר את מכסי המערכת. כדי לעשות זאת:

1. יש לפתוח את המנעול התלוי ולהסירו מגב המערכת אם אכן הותקן בה מנעול תלוי.
2. יש להסיר את כל הברגים של המכסים ולשמור אותם.
3. יש להסיר את המכסים.

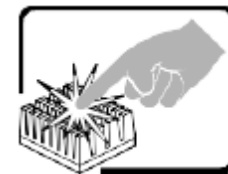


לקירור ולזרימת אוויר תקינים, יש תמיד להתקין מחדש את מכסי המעטפת לפני הפעלת המערכת. הפעלת המערכת ללא המכסים במקומם, עלולה לגרום נזק לחלקי המערכת. להתקנת המכסים:



1. יש לבדוק תחילה כדי לוודא שלא נשארו כלים או חלקים רופפים בתוך המערכת.
2. יש לבדוק שהכבלים, הלוחות הנוספים ורכיבים אחרים מותקנים כראוי.
3. יש לחבר את המכסים למעטפת עם הברגים שהוסרו קודם לכן ולהדק אותם בחוזקה למקומם.
4. יש להכניס את מנעול התליה למערכת ולנעול אותו כדי למנוע גישה בלתי מורשית לפני המערכת.
5. יש לחבר את כל הכבלים החיצוניים ואת כבל(\*) חשמל ז"ח למערכת.

מעבד המיקרו ומפזר החום עלולים להיות להוטים כשהמערכת פועלת. כמו כן, ייתכנו סיכות וקצוות חדים בחלקי לוח ומעטפת שונים. יש לגעת בזהירות. יש לשקול עטיית כפפות מגן.



סכנת פיצוץ אם הסוללה מוחלפת באופן שגוי. יש להחליף רק באותו סוג או שווה ערך שמומלץ על ידי יצרן הציוד. יש להשליך סוללות משומשות על פי הוראות היצרן.



המערכת נועדה לפעול בסביבה משרדית טיפוסית. יש לבחור אתר שהוא:

- נקי וחופשי מחלקיקים נישאים באוויר (למעט אבק שקיים באופן רגיל בחדר).
- מאוורר היטב ורחוק ממקורות חום כולל אור שמש ישיר.
- יש להרחיק ממקורות רטט או זעזועים פיזיים.
- מבודד משדות אלקטרומגנטיים חזקים שנגרמים על ידי מכשירים חשמליים.
- באזורים שרגישים לסערות חשמל, אנו ממליצים לחבר את המערכת למדכא נחשול, ובמהלך סערה חשמלית לנתק קווי תקשורת שמחוברים למודם שלכם.
- בעל שקע קיר מוארק כהלכה.
- בעל מספיק מקום לגישה חופשית לכבל(\*) החשמל, מכיוון שהוא/הם משמש(ים) לניתוק רשת החשמל למוצר.

